

Architectural & Metal Systems

MU 144.91 Lift & Slide door

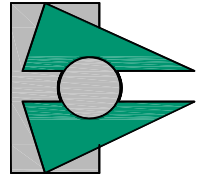

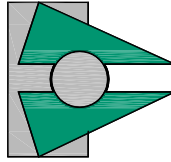

**PAGE**

ALUMINIUM PROFILES	<b>1 - 1 to 1 - 4</b>
ACCESSORIES, GLAZING, CONFIGURATIONS & SPAN CHARTS / Glass sizes	<b>2 - 1 to 2 - 7</b>
ASSEMBLY DETAILS	<b>3 - 1 to 3 - 12</b>
INSTALLATION / GLAZING	<b>4 - 1 to 4 - 2</b>

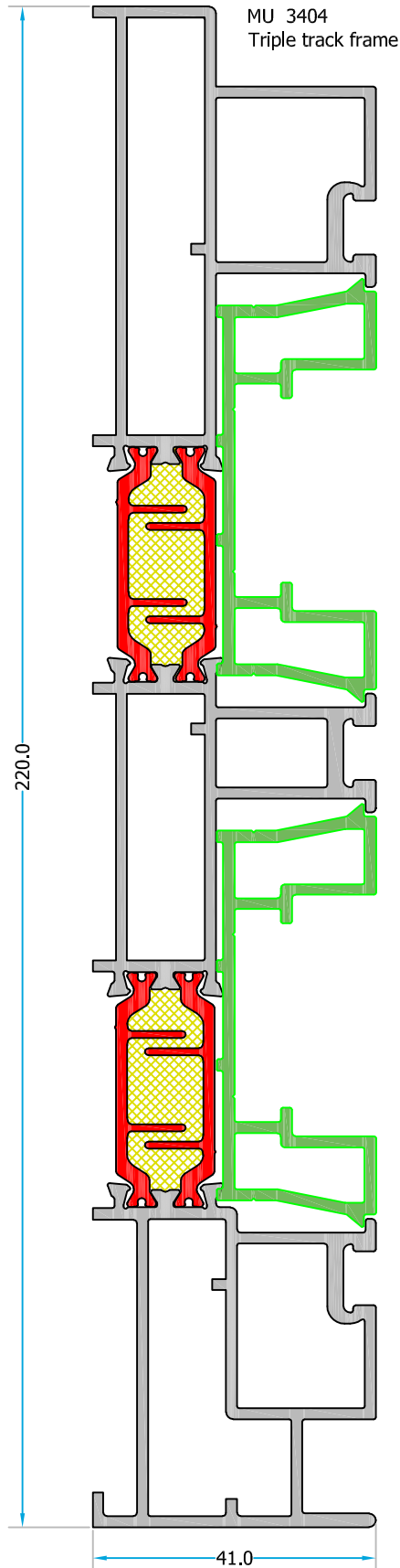
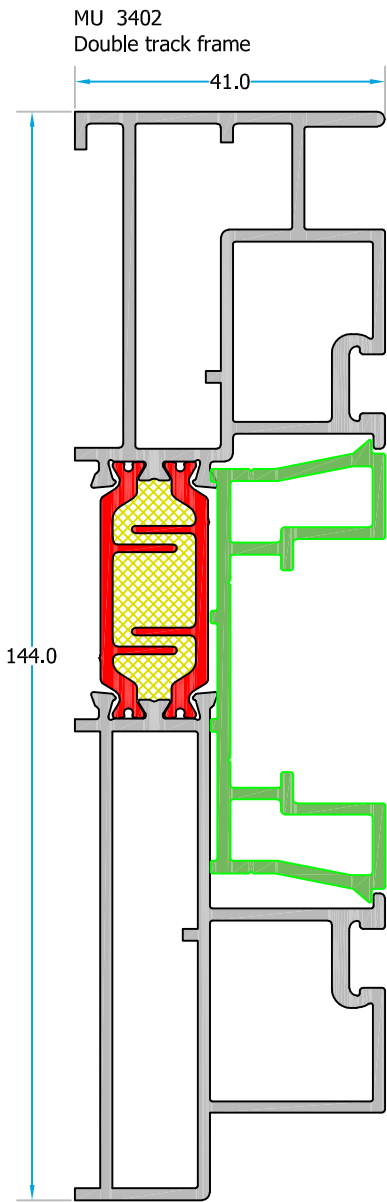
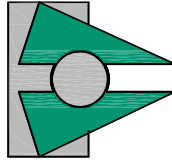

MU 3411  
4 pane adapter

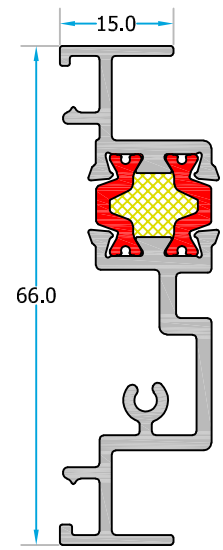

MU 3405  
Head central adapter

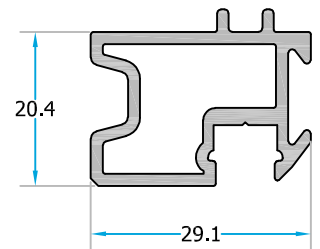

MU 3406  
Head central adapter -  
Triple track

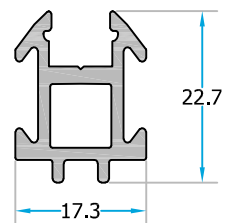

MU 3115  
Track

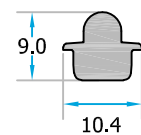

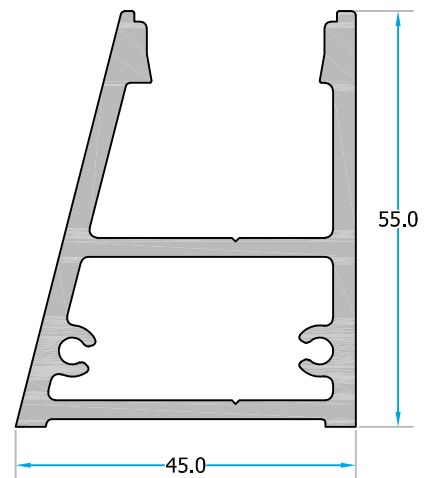
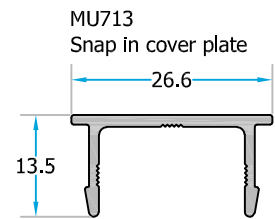
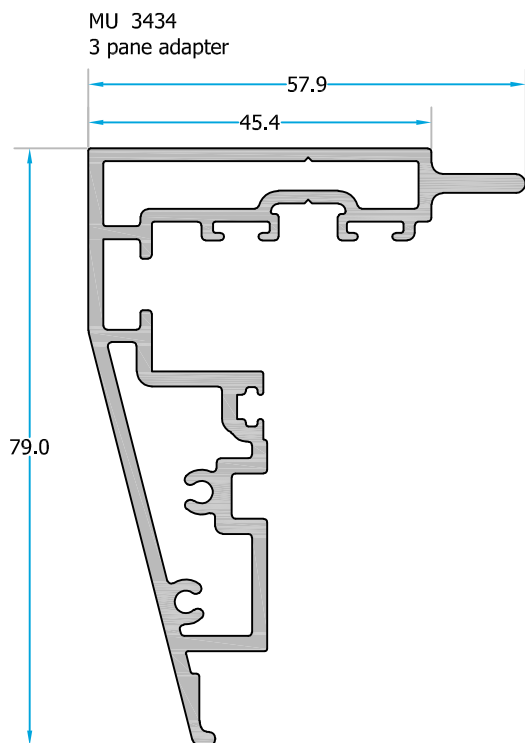
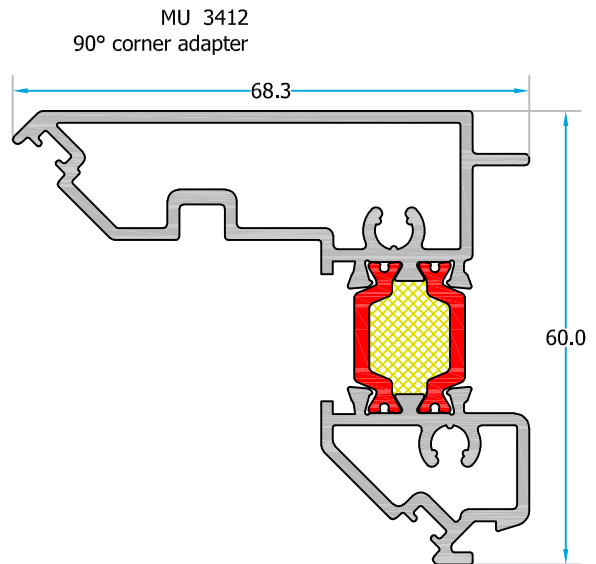
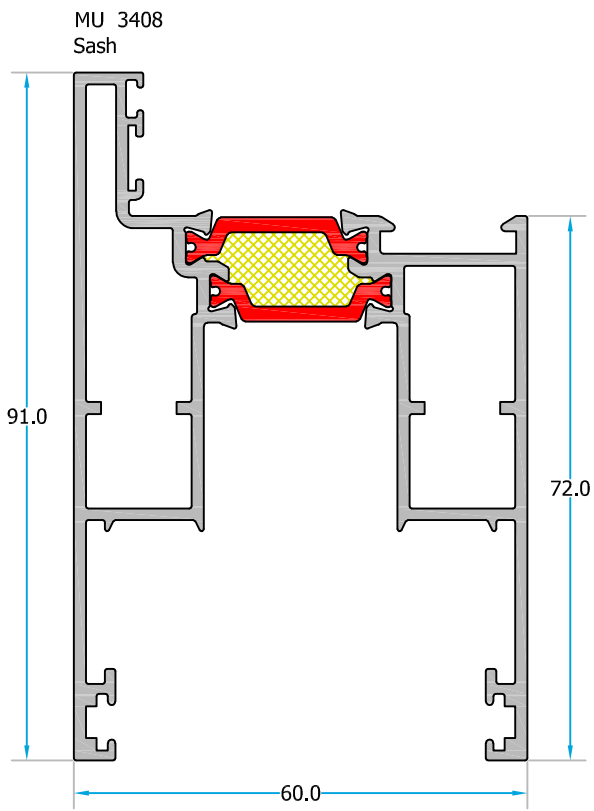
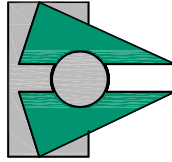

MU 1824  
Reinforcing profile - See drawing  
2-5 for spans



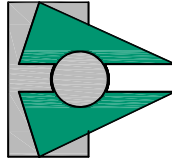

MU 3416  
Internal head adapter

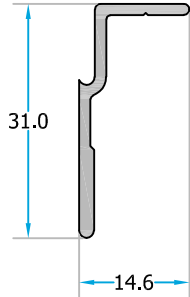

MU 3417  
External head adapter

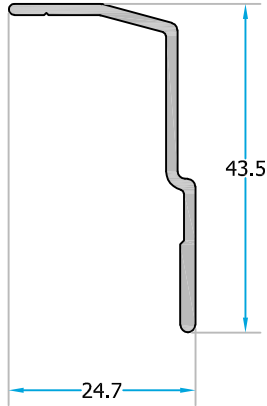

MU 3415  
Insert

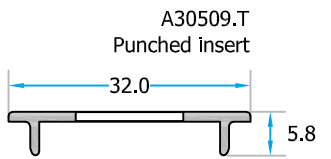
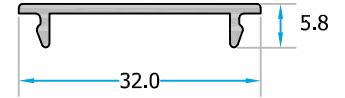

MU 3418  
Closer plate - sill

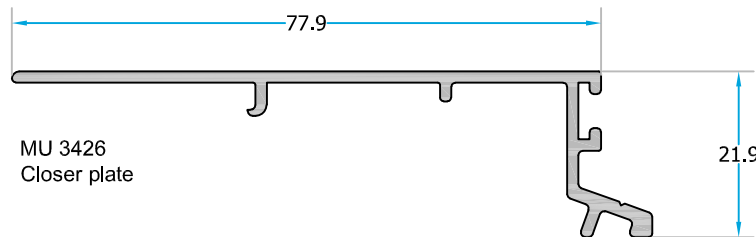
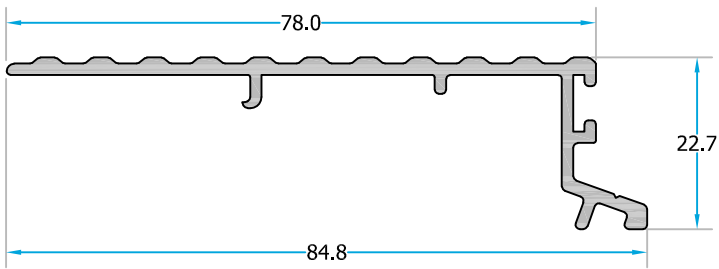

MU 3426  
Closer plate

MU 3410  
Interlock cover

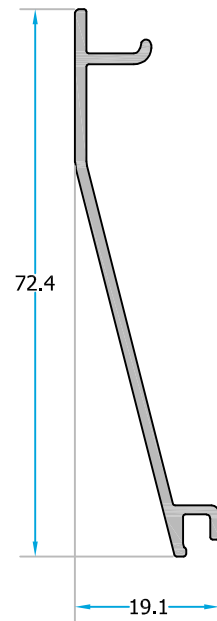

MU 2052  
28mm bead

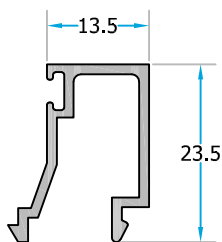

MU 53402  
30 / 32mm bead

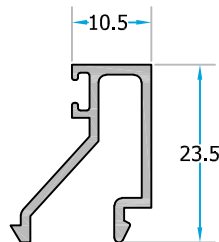

MU 2059  
38 / 40mm bead

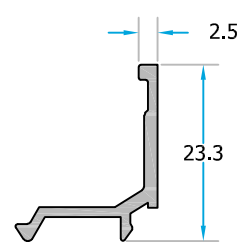

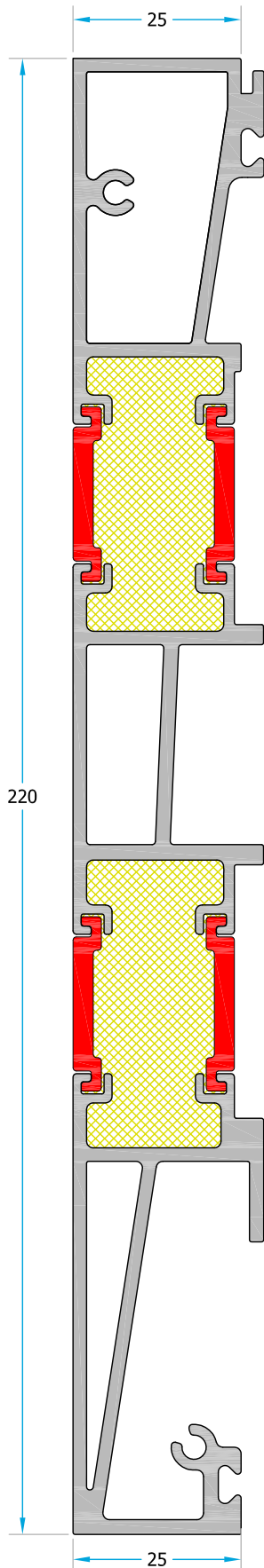
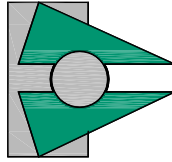



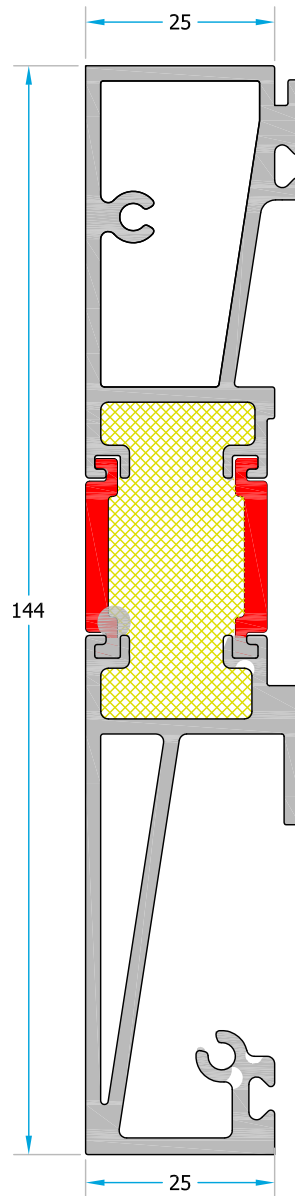



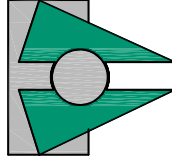



LSC 220  
Sill drainage adapter -  
triple track







LSC 144  
Sill drainage adapter -  
single track



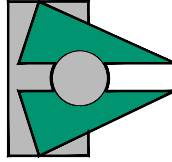

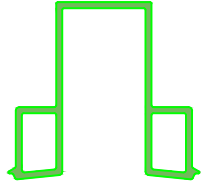

Push-in External glazing gasket	A01301	
Glazing wedge 5 mm	A01305	
Glazing wedge 6 mm	A01306	
Glazing wedge 7-8 mm	A01307	
Seal gasket for corner sliding	A01319	
Seal gasket for MU 3434	A01322	
Seal gasket for leaf	A01341	
Seal gasket for middle stile	A01342	
Guide gasket	A01901	
Interlock woolpile (Black) - 6.7 x 900	LSA025	





All gaskets should be joint with EPDM compatible glue

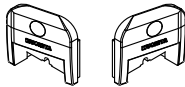
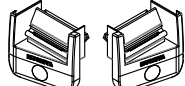
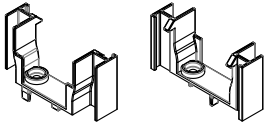
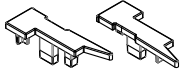
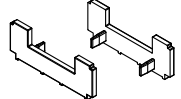

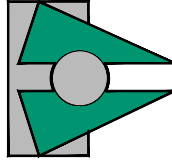
Frame insert	A30500	
Sash insert	A30503	
Head insert for MU3405 & MU3406	A30504	
Interlock adapter	A30506	

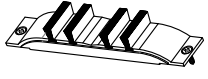
Frame cleat	A02201	
Sash cleat	A02211	
Sash chevron	A02304	
PVC sash chevron	A02906	
PVC guide chevron	A02907	
Bottom interlock end caps - LH & RH	A03166L A03166R	
top interlock end caps - LH & RH	A03167L A03167R	
Pair of end cover for MU 3411	A03168	
End caps for PVC interlock profile	A03169	
End caps for pvc frame guide	A03170	

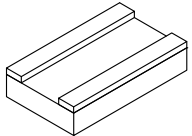
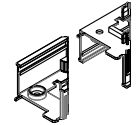
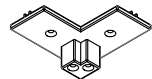
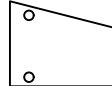

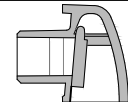
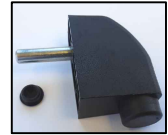
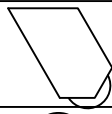
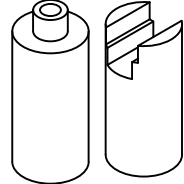
Head seal	A03172	
Head brush seal for MU 3405 & MU 3406	A03173	
Foam seal at sill MU 3408	A03175	
End caps for 90° corner adapter MU 3412	A03177	
Stop profile for 90° corner profile MU 3412	A03178	
Closer plate for re-inforcing profile MU1824	MU1824EC	
End Cap for sill add on profile LSC144	LSC144EC	
Riv-nut for lock and roller gear	A32150	
Drainage cap kit	A24901	
Sash stop	A24601	
Drainage valves	LSA024	
Fixed sash spacer blocks	A03186	

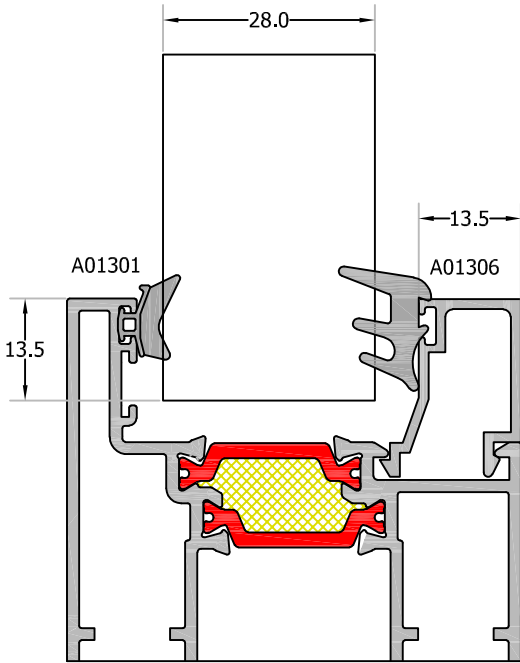
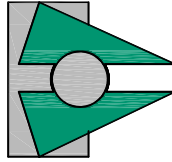

28mm Glazing

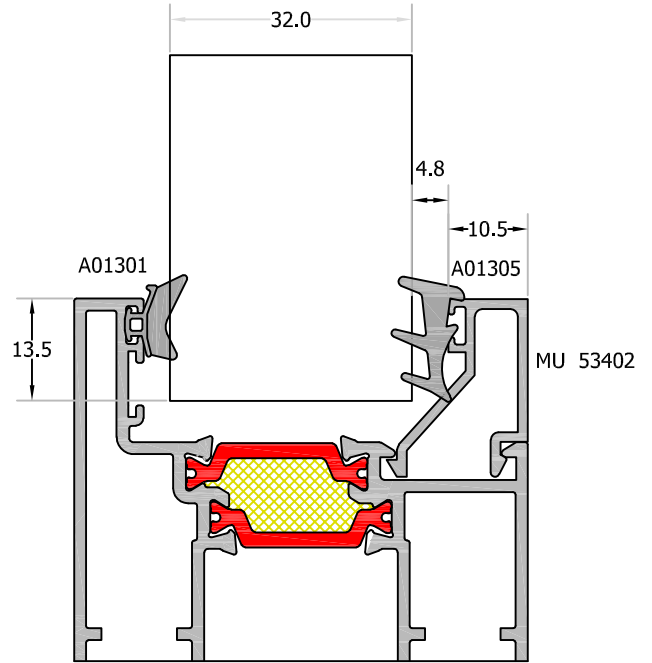

32mm Glazing

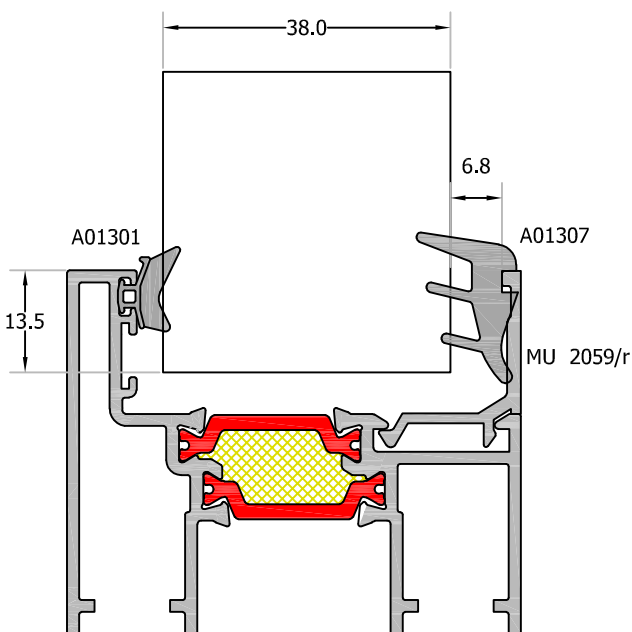

38mm Glazing

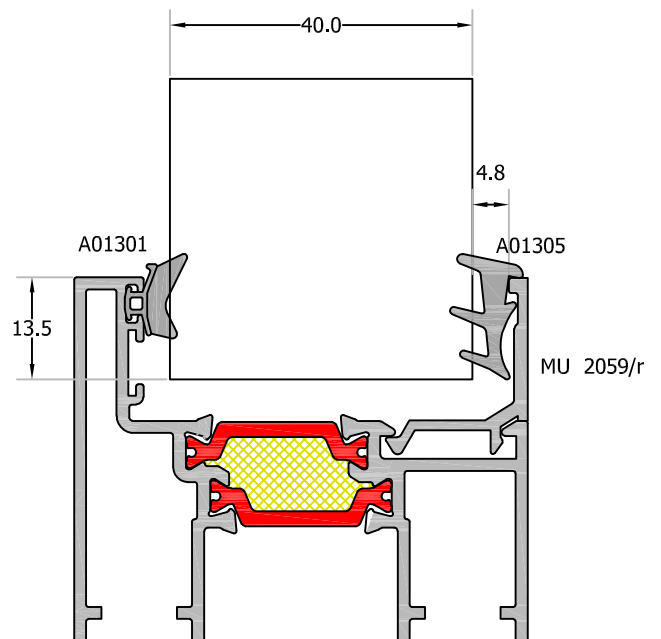

40mm Glazing

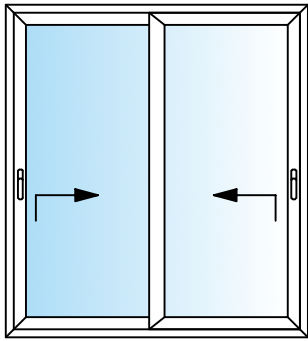
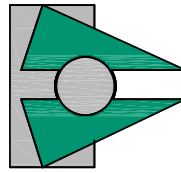

2 Pane - 2 sliding sashes

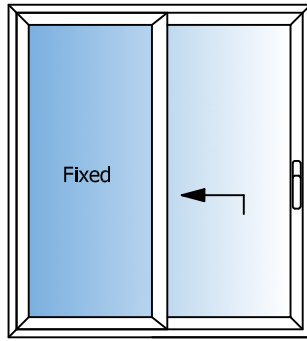

2 Pane - 1 sliding sash & 1 fixed sash

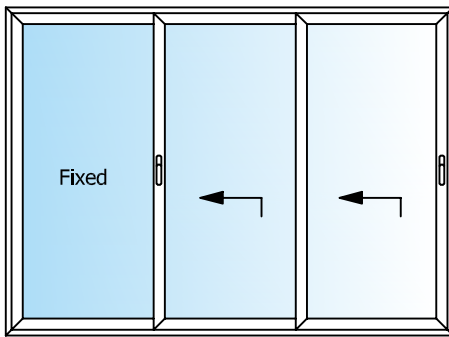

3 Pane - Triple track - 2 sliding sashes & 1 fixed sashes

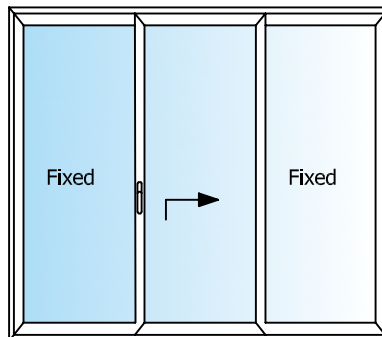

3 Pane - 1 sliding sash & 2 fixed sashes

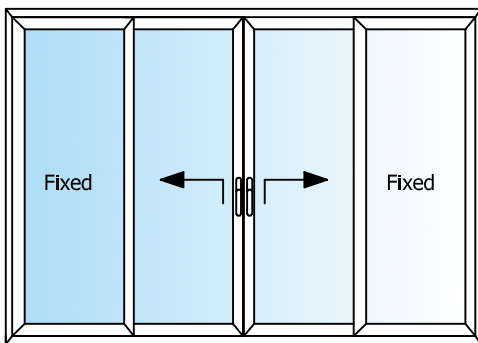

4 Pane - 2 sliding sashes & 2 fixed sashes

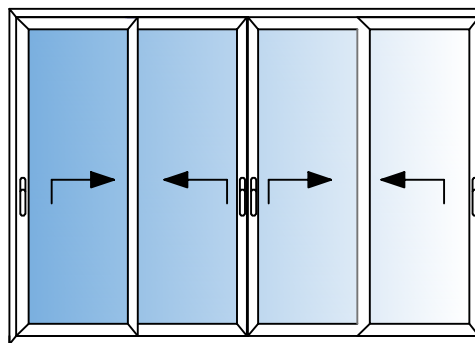

4 Pane - 4 sliding sashes

Internal corner and external corner doors possible

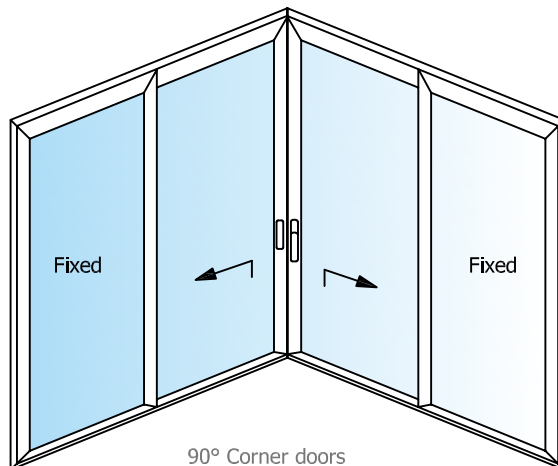

90° Corner doors

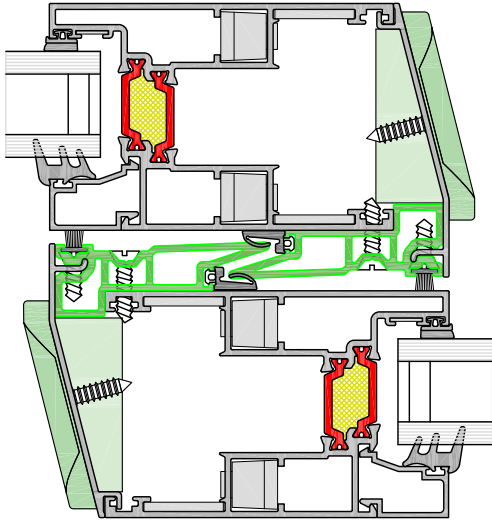
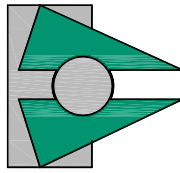

Standard Interlock detail

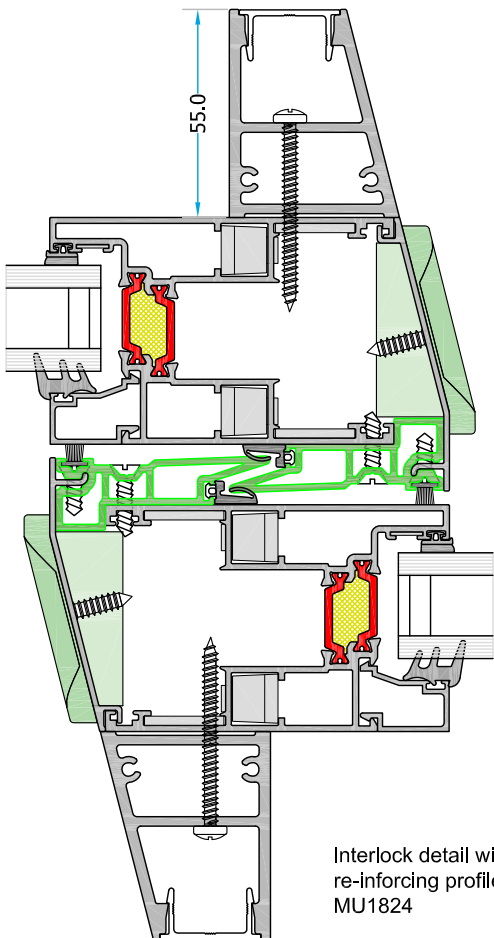
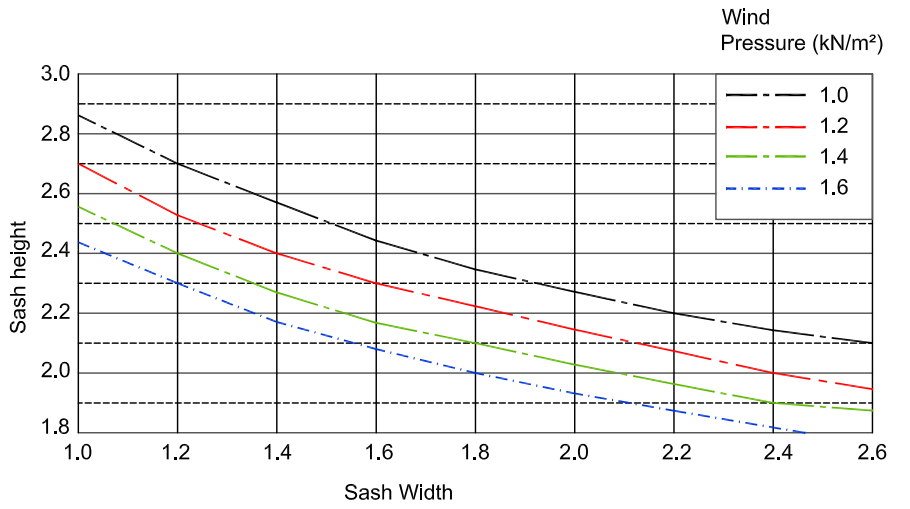

Interlock detail with re-inforcing profile MU1824

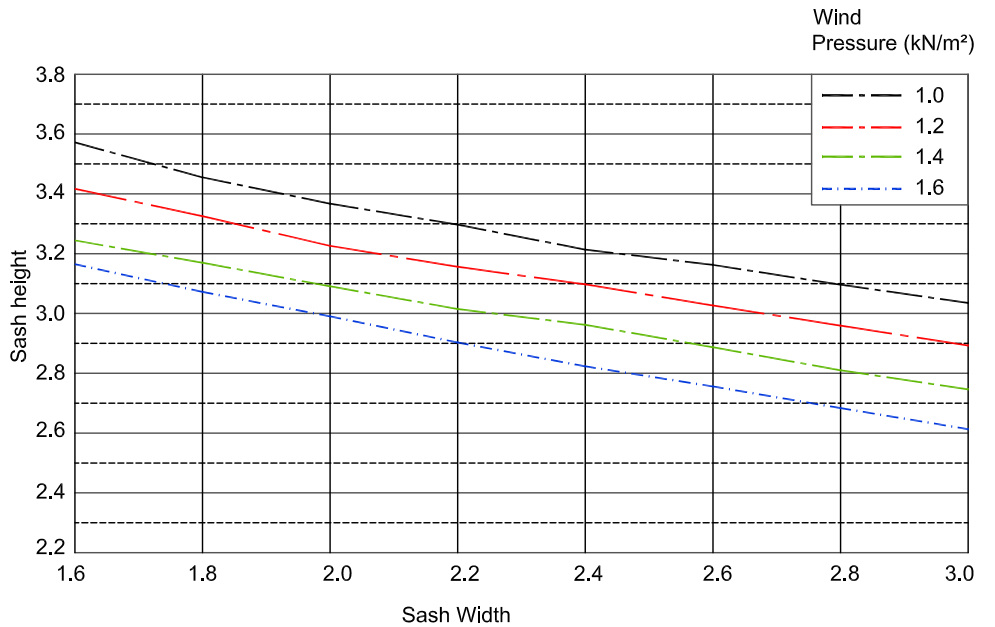



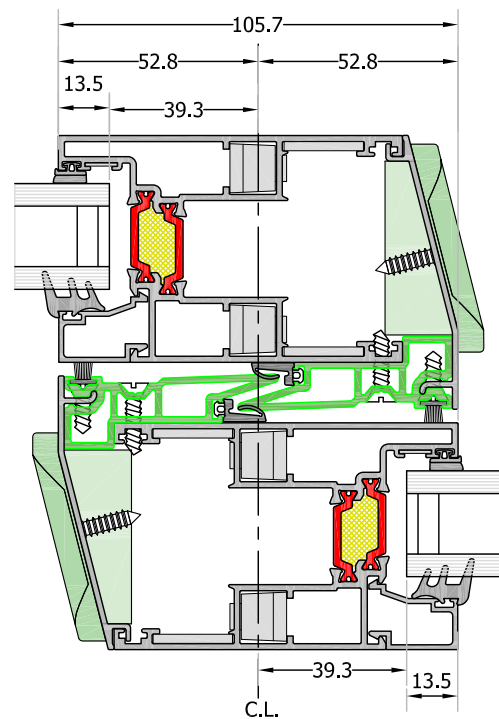
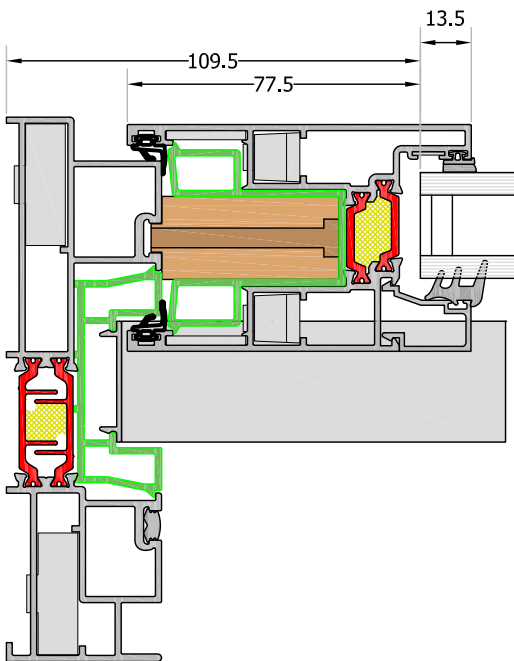
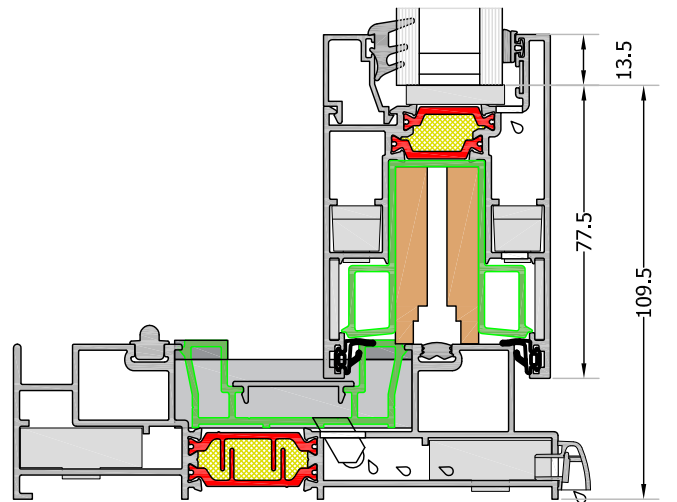
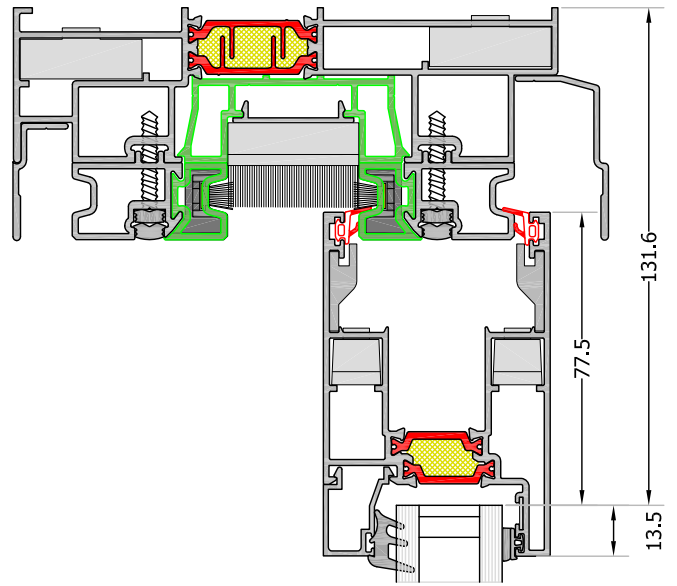
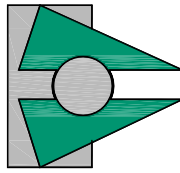

TYPICAL DETAILS

Drainage

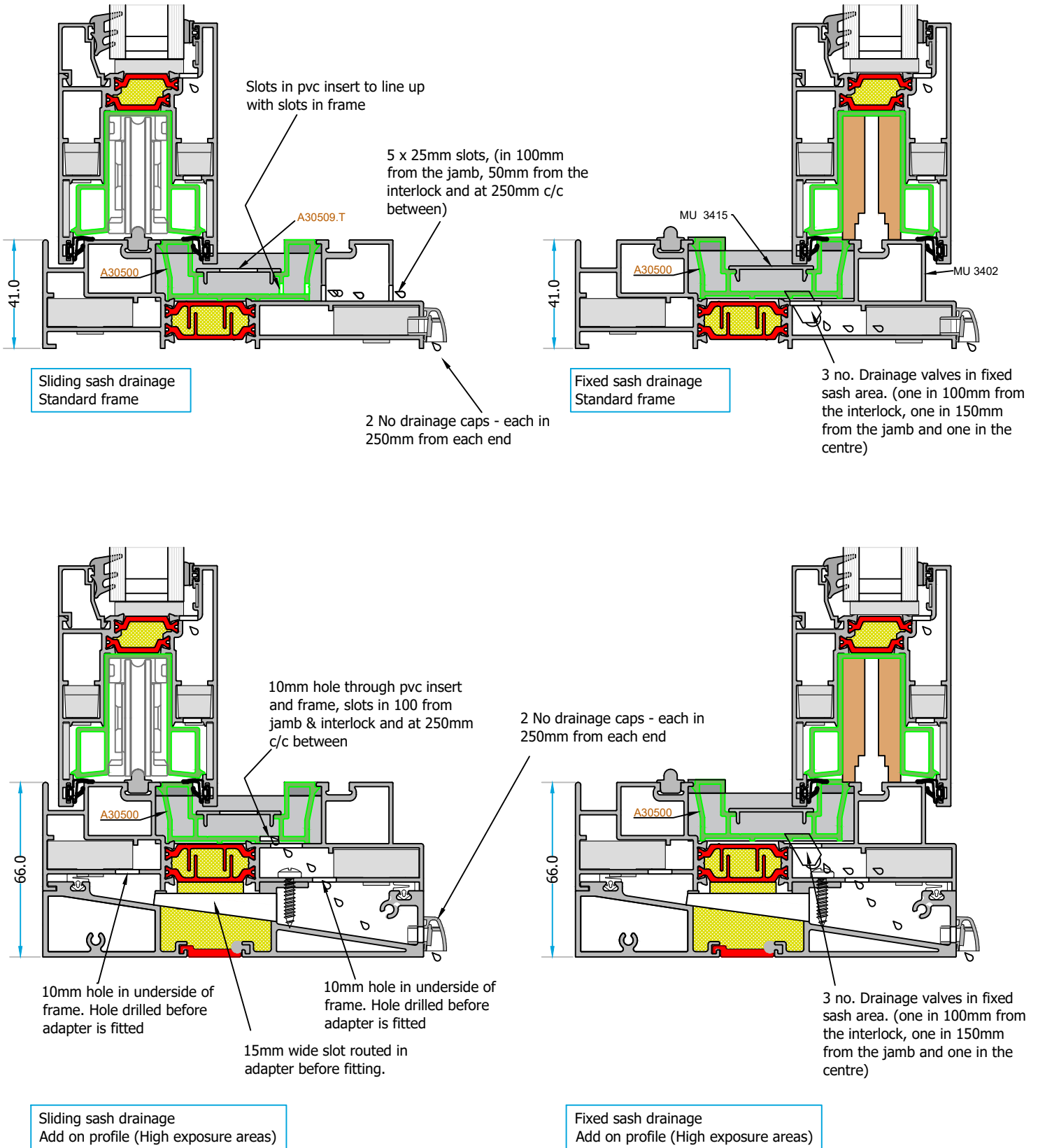
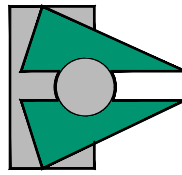

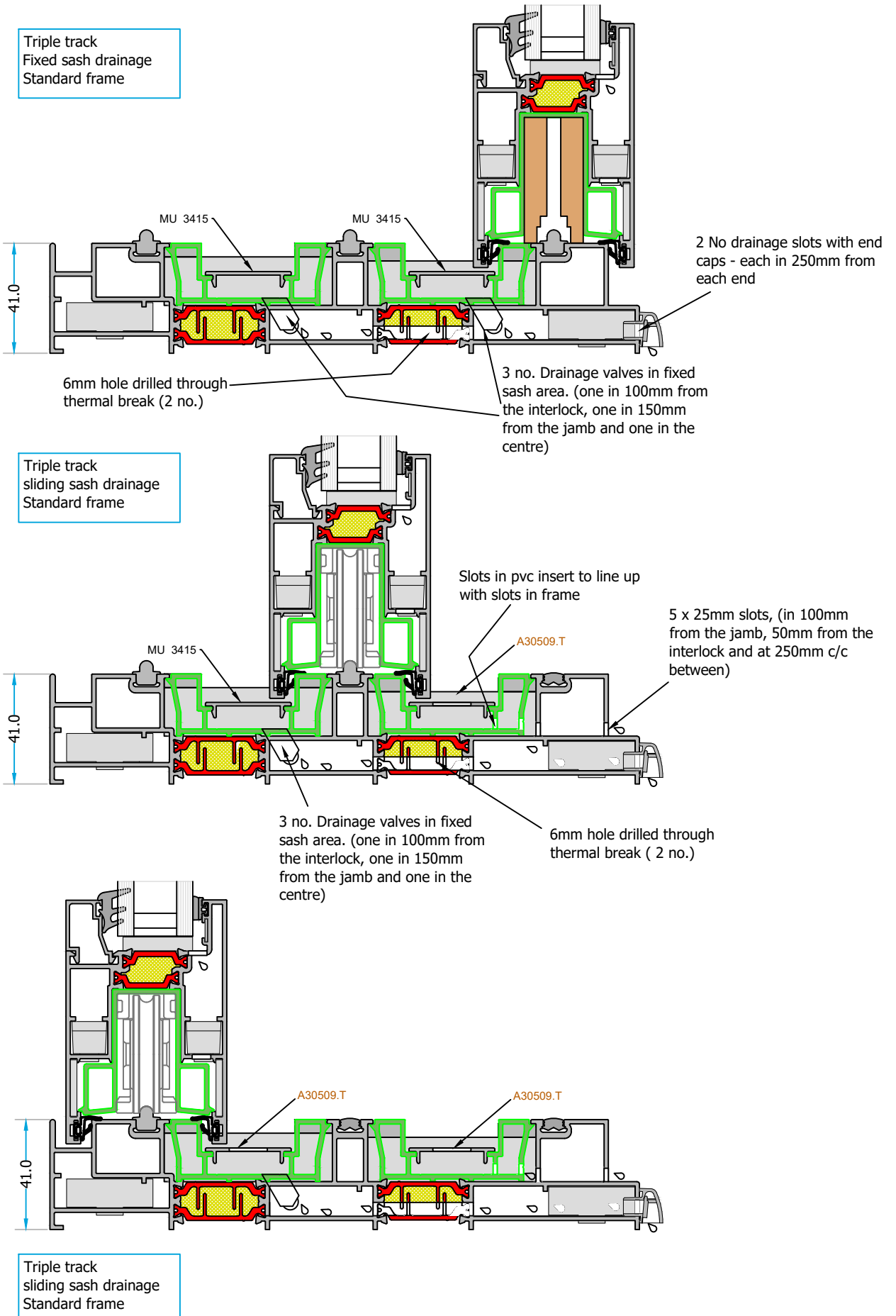
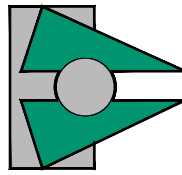

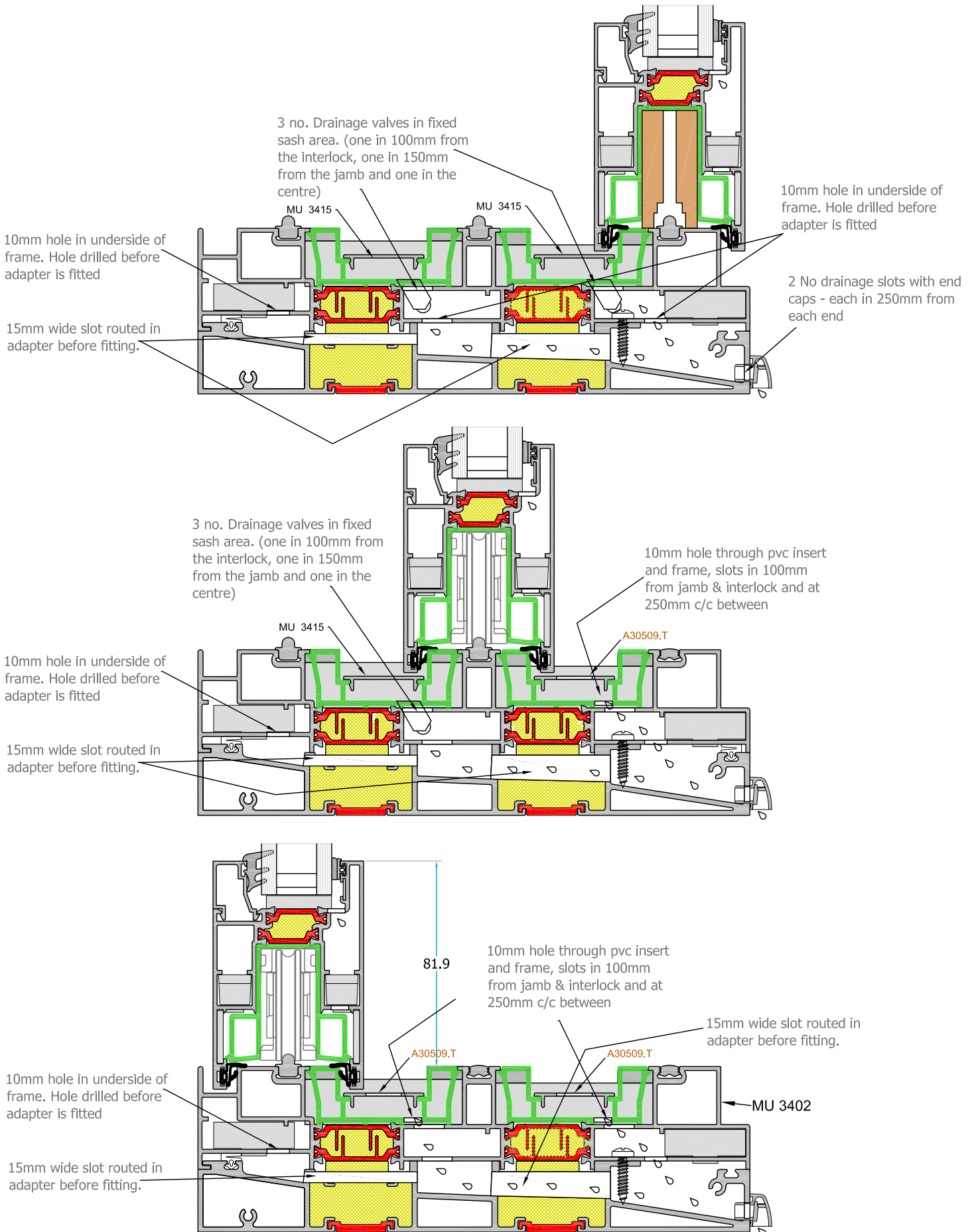
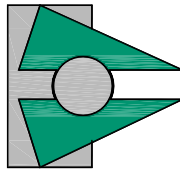

TYPICAL DETAILS

Two Pane - 2 sliders

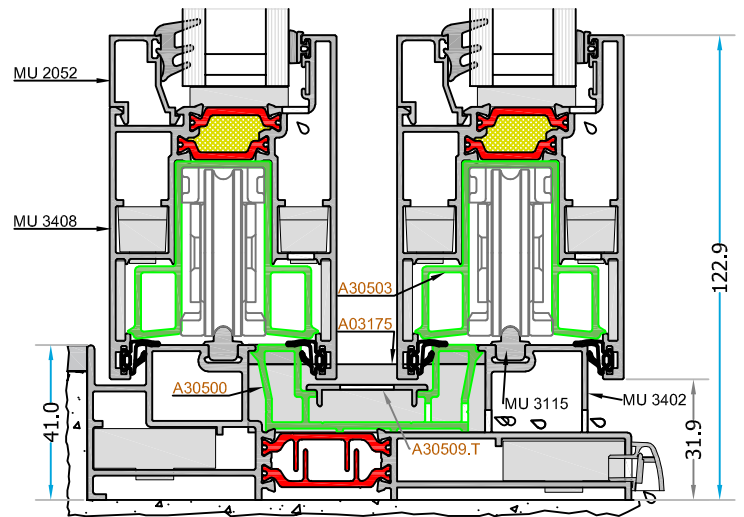
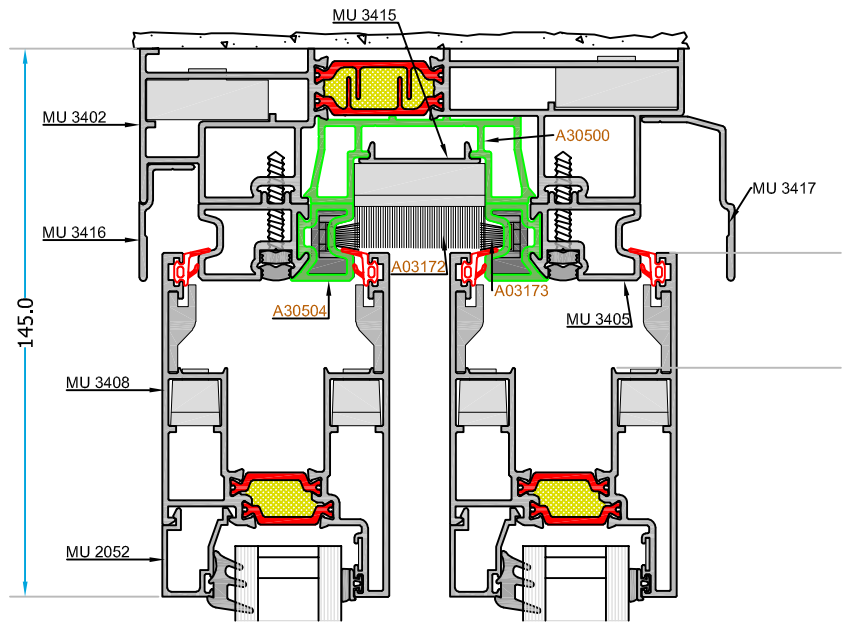
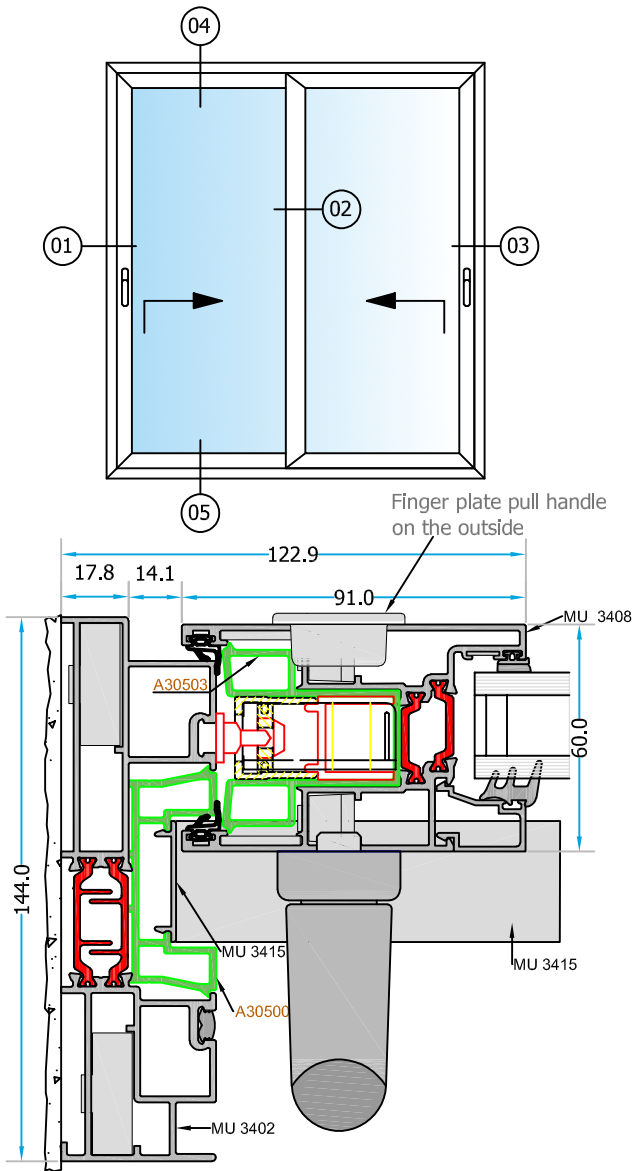
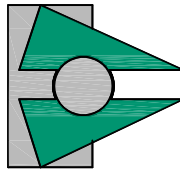

Note: For option with sill add on profile see drawing 3-9

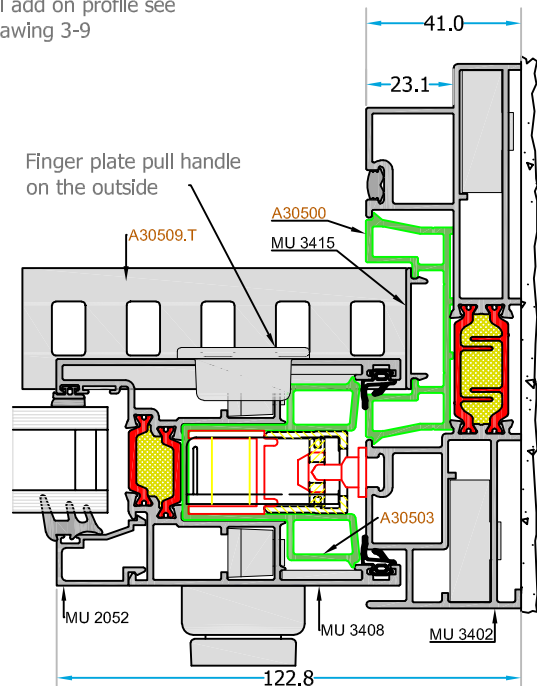
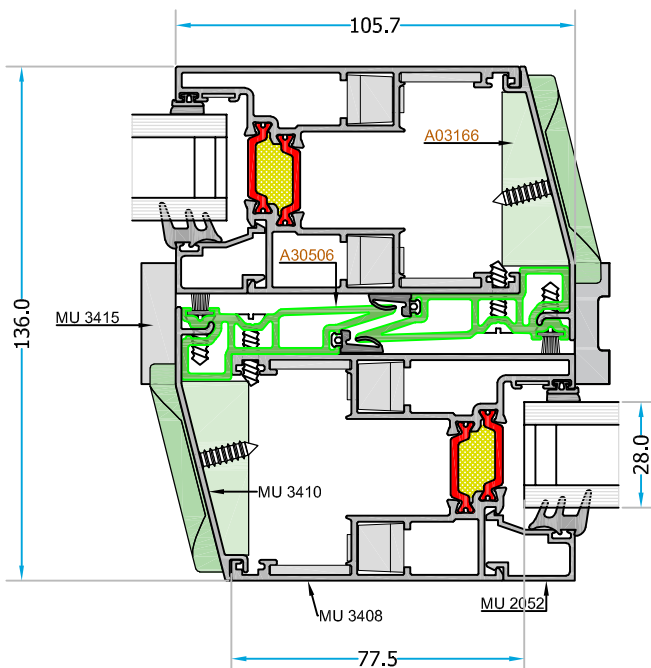

TYPICAL DETAILS

Two Pane - 1 sliding & 1 fixed

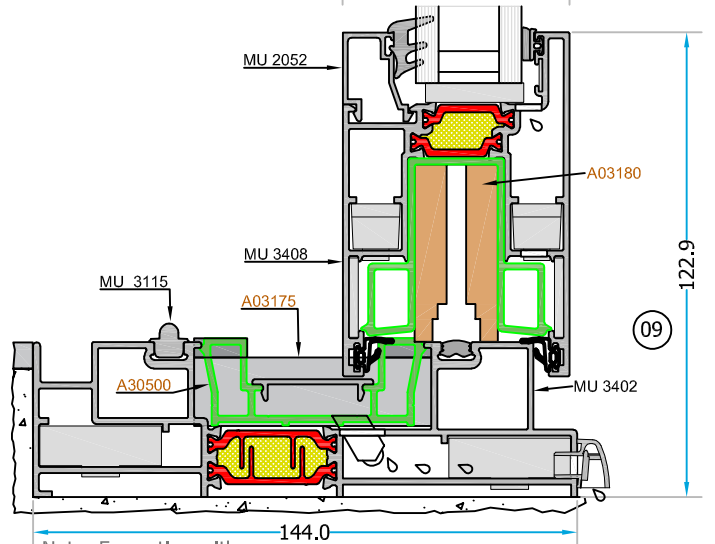
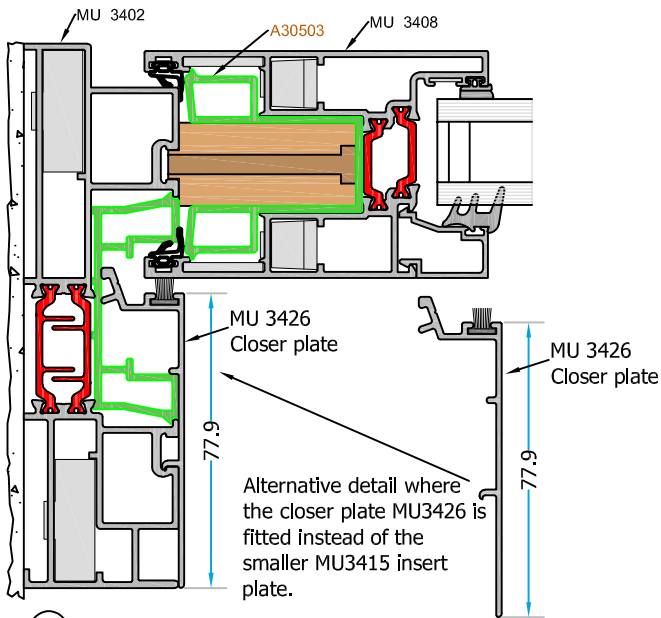
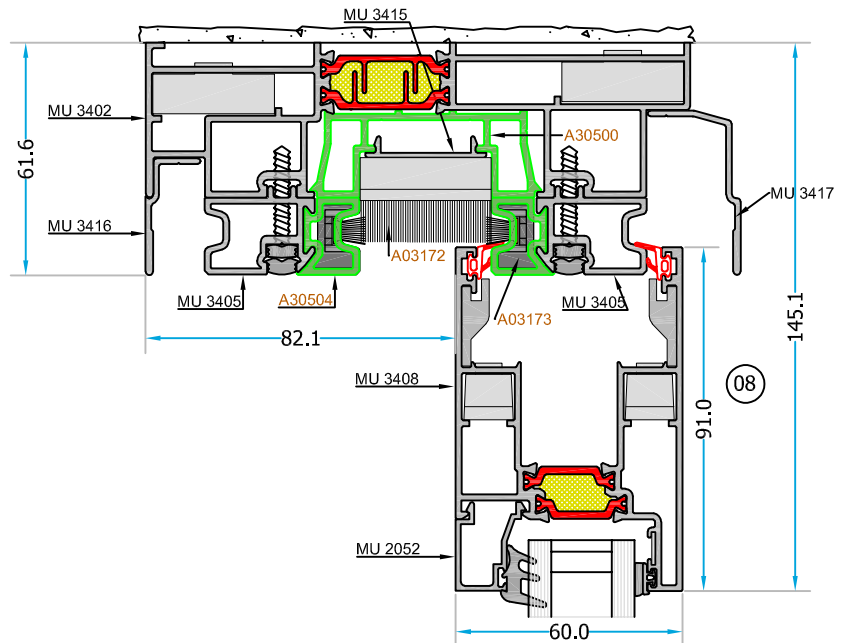
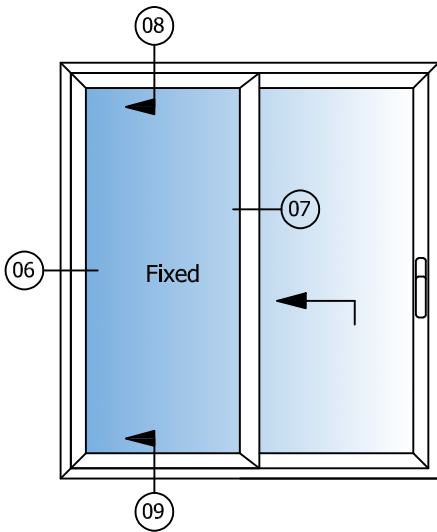
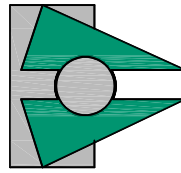

Note: For option with sill add on profile see drawing 3-9

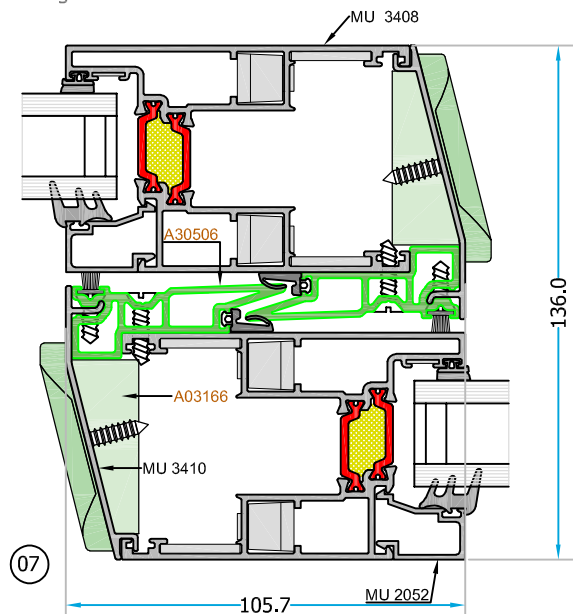
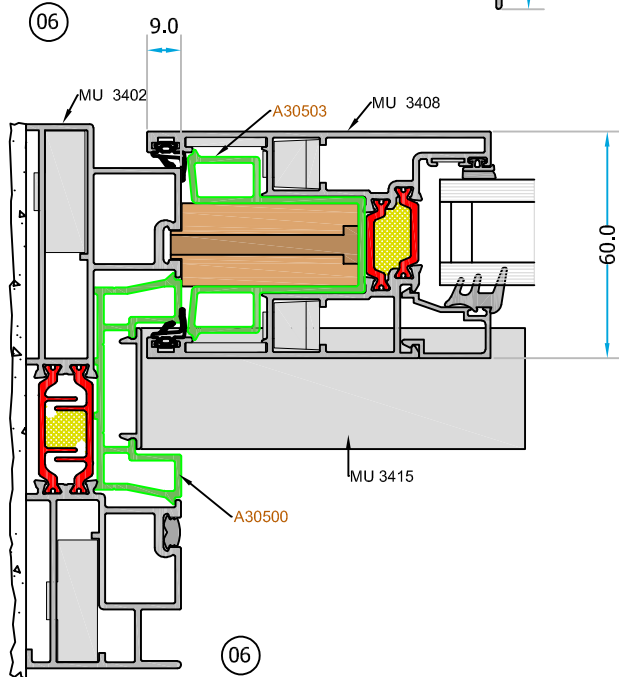



TYPICAL DETAILS

Two Pane - 1 sliding & 1 fixed

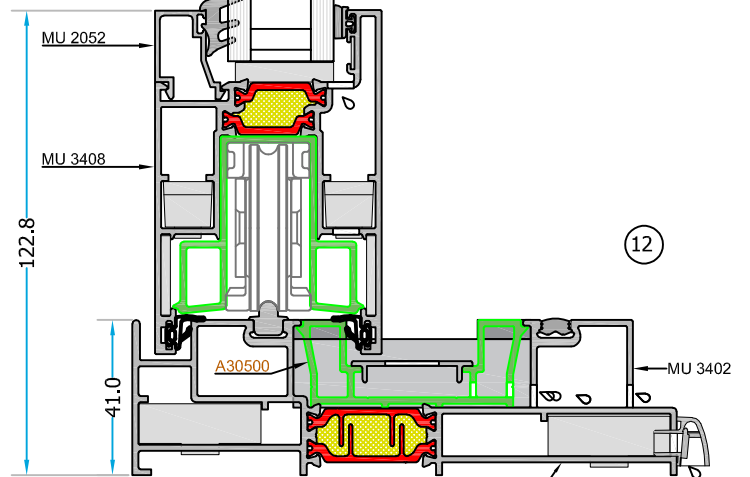
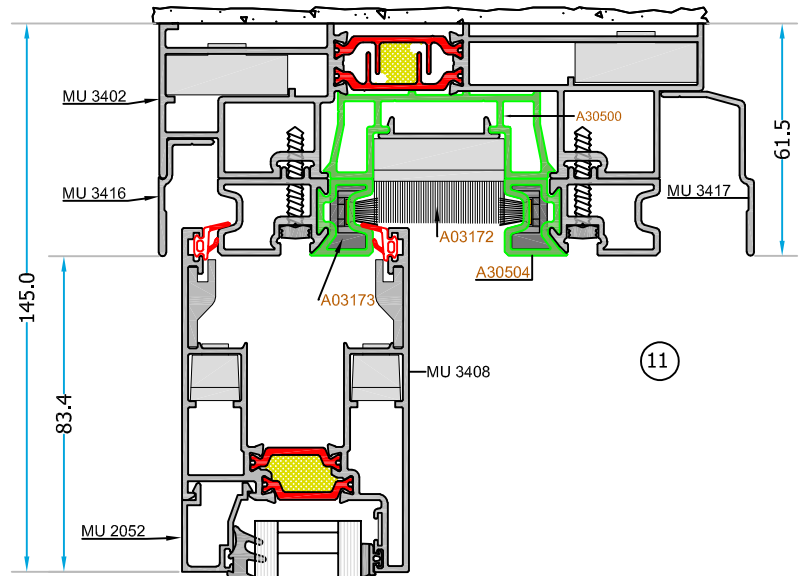
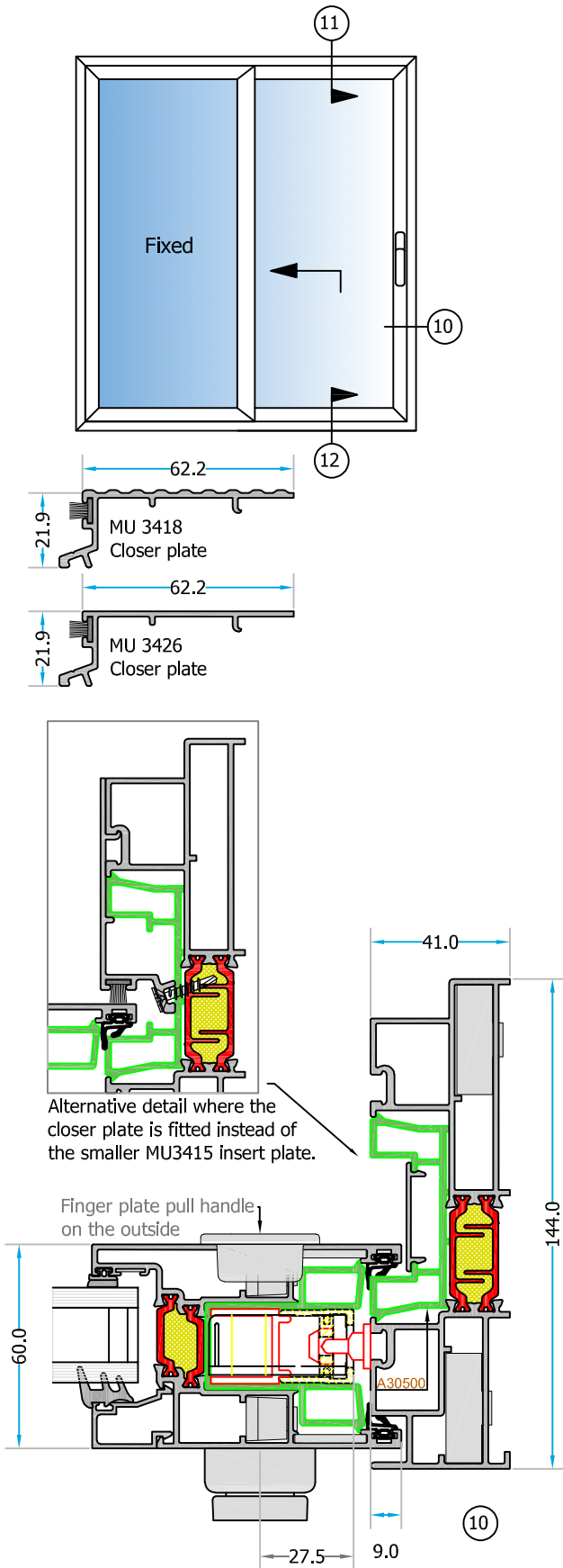
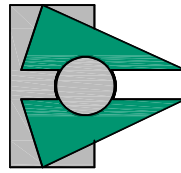

Note: For option with sill add on profile see drawing 3-9

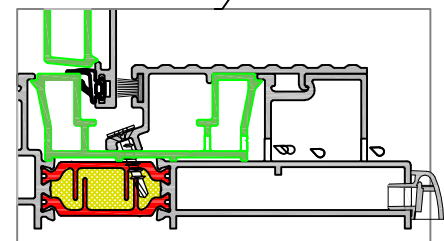

Alternative sill detail where the closer plate MU3418 (Cut down) is fitted instead of the A30509.T punched insert plate.

TYPICAL DETAILS

Three pane - 1 sliding & 2 fixed

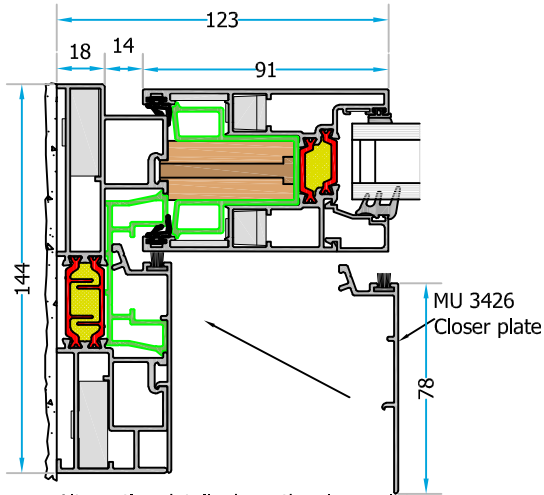
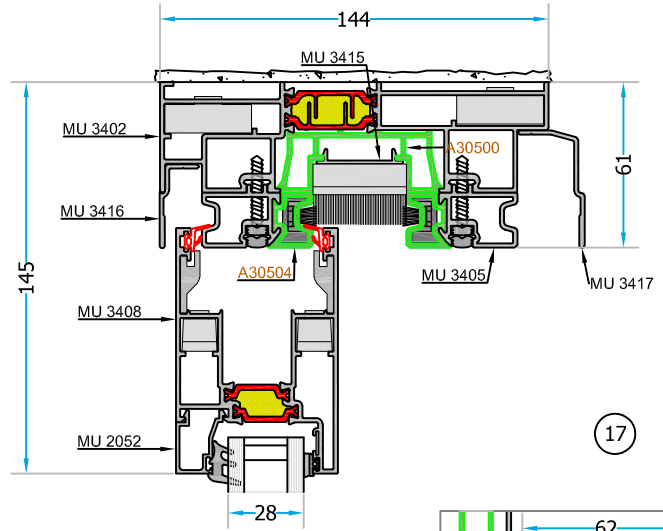
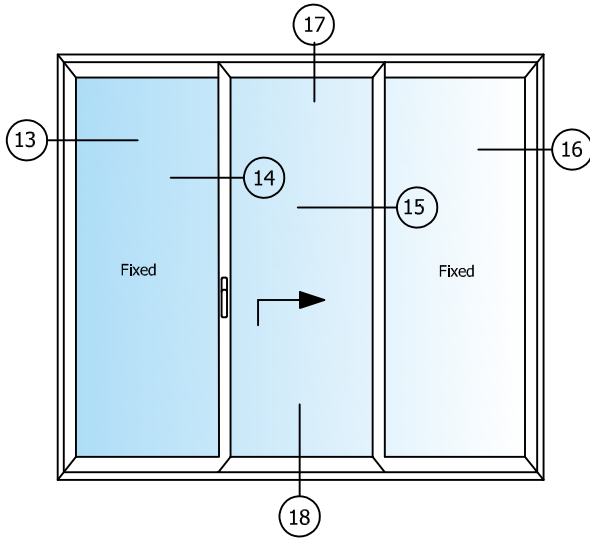
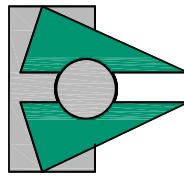

Alternative detail where the doser plate MU3426 is fitted instead of the smaller MU3415 insert plate (on both jambs).

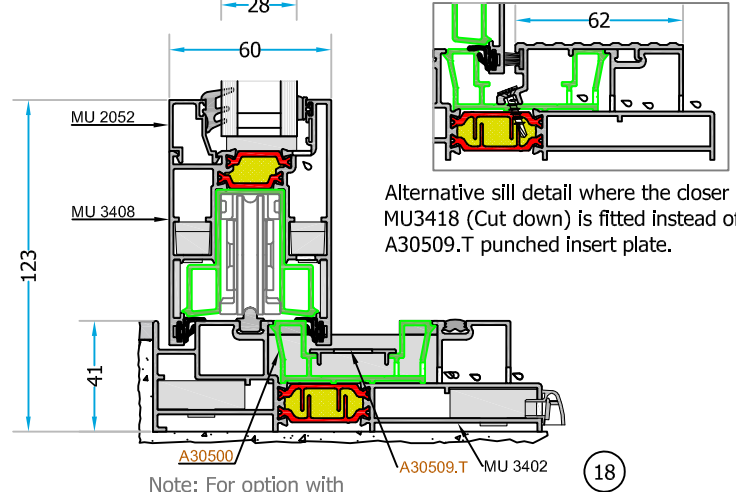

Alternative sill detail where the doser plate MU3418 (Cut down) is fitted instead of the A30509.T punched insert plate.

Note: For option with sill add on profile see drawing 3-9

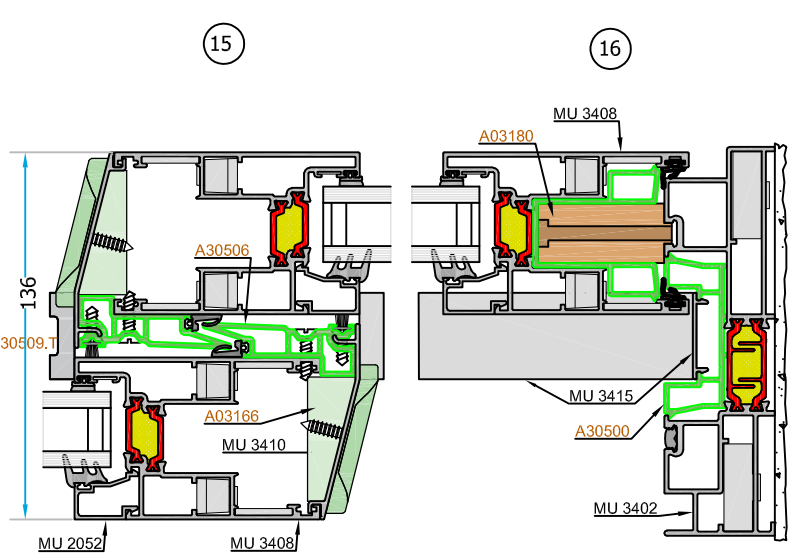
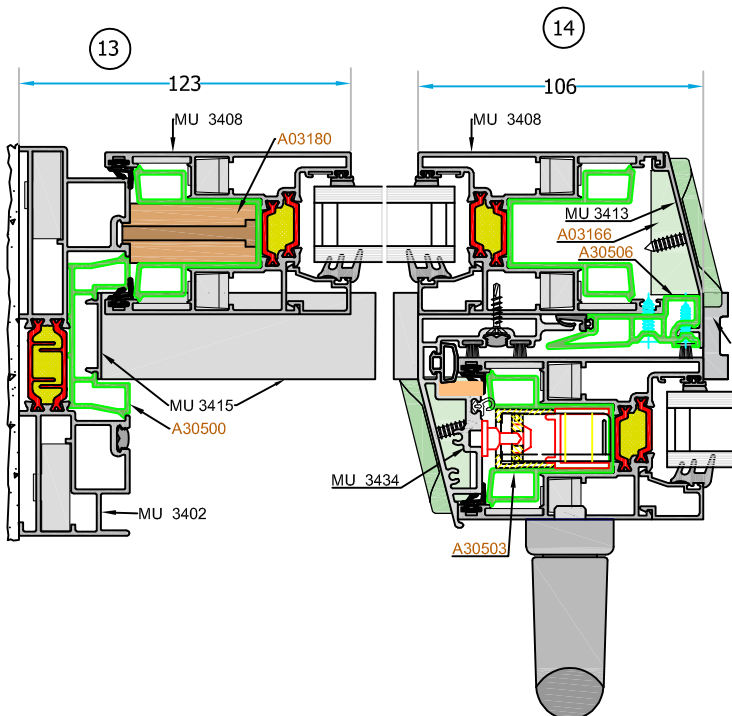



TYPICAL DETAILS

Three pane - 1 sliding & 2 fixed

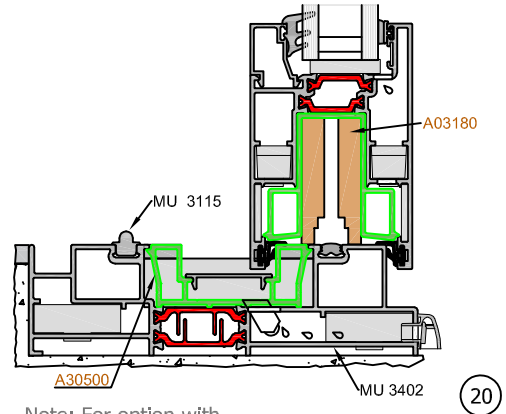
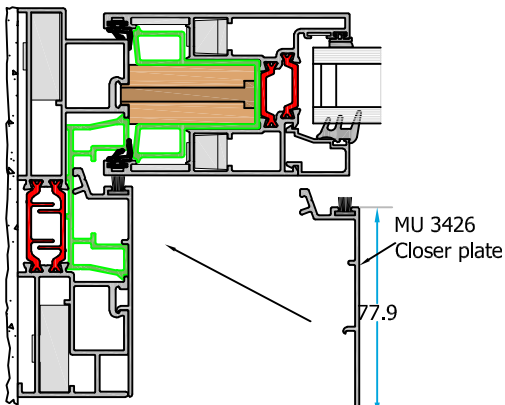
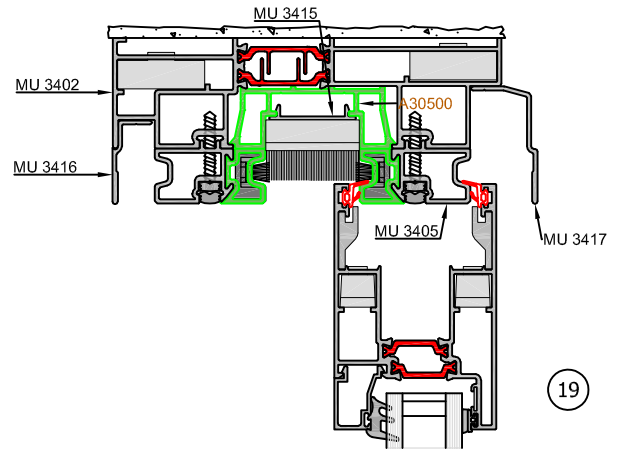
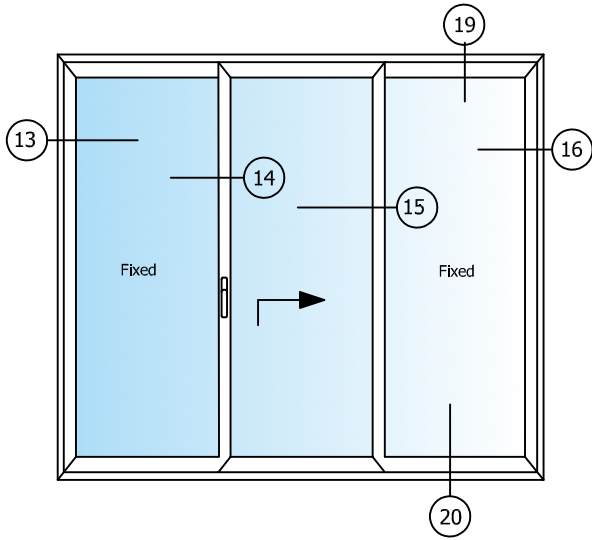
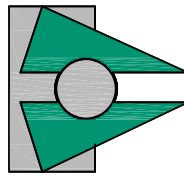

Note: For option with sill add on profile see drawing 3-9

Alternative detail where the closer plate MU3426 is fitted instead of the smaller MU3415 insert plate (on both jambs).

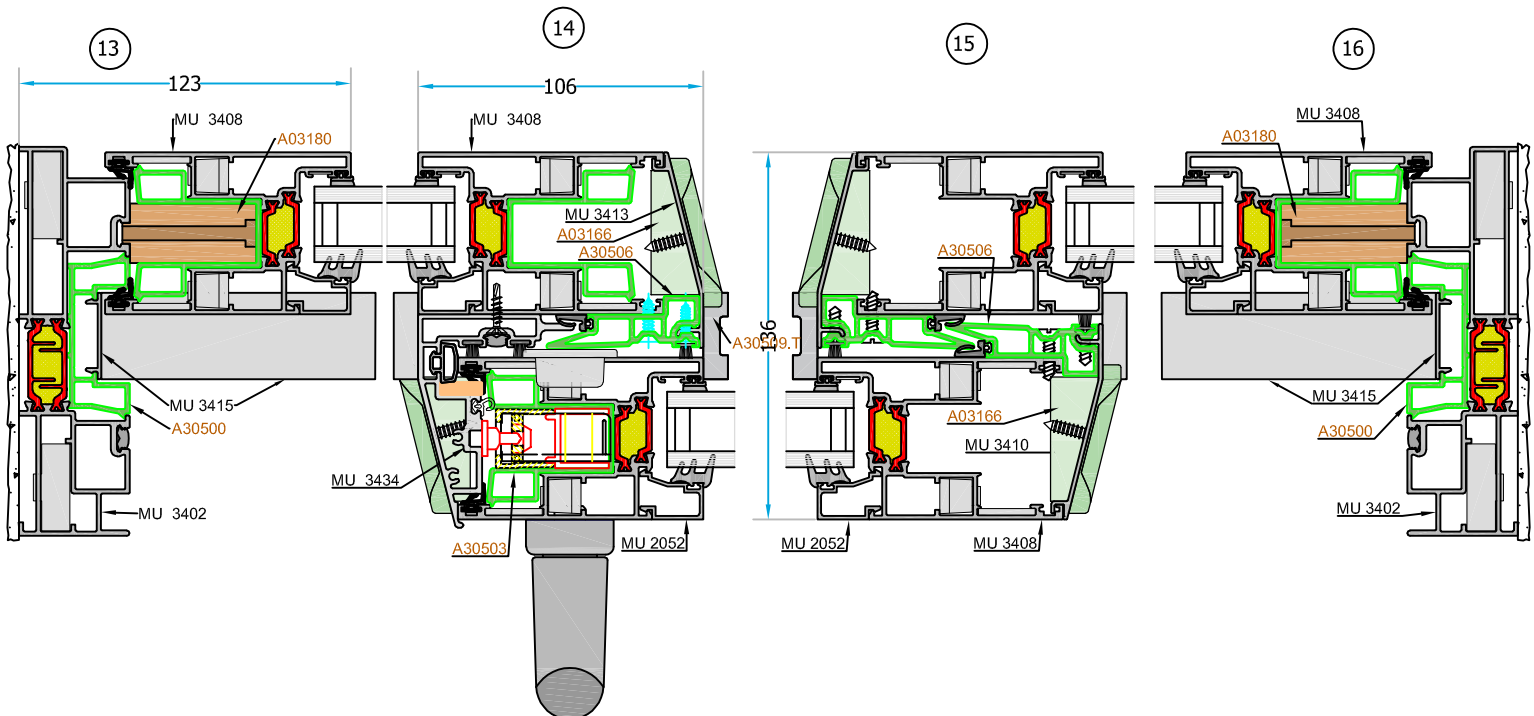

TYPICAL DETAILS

Three pane triple track - 2 sliding & 1 fixed

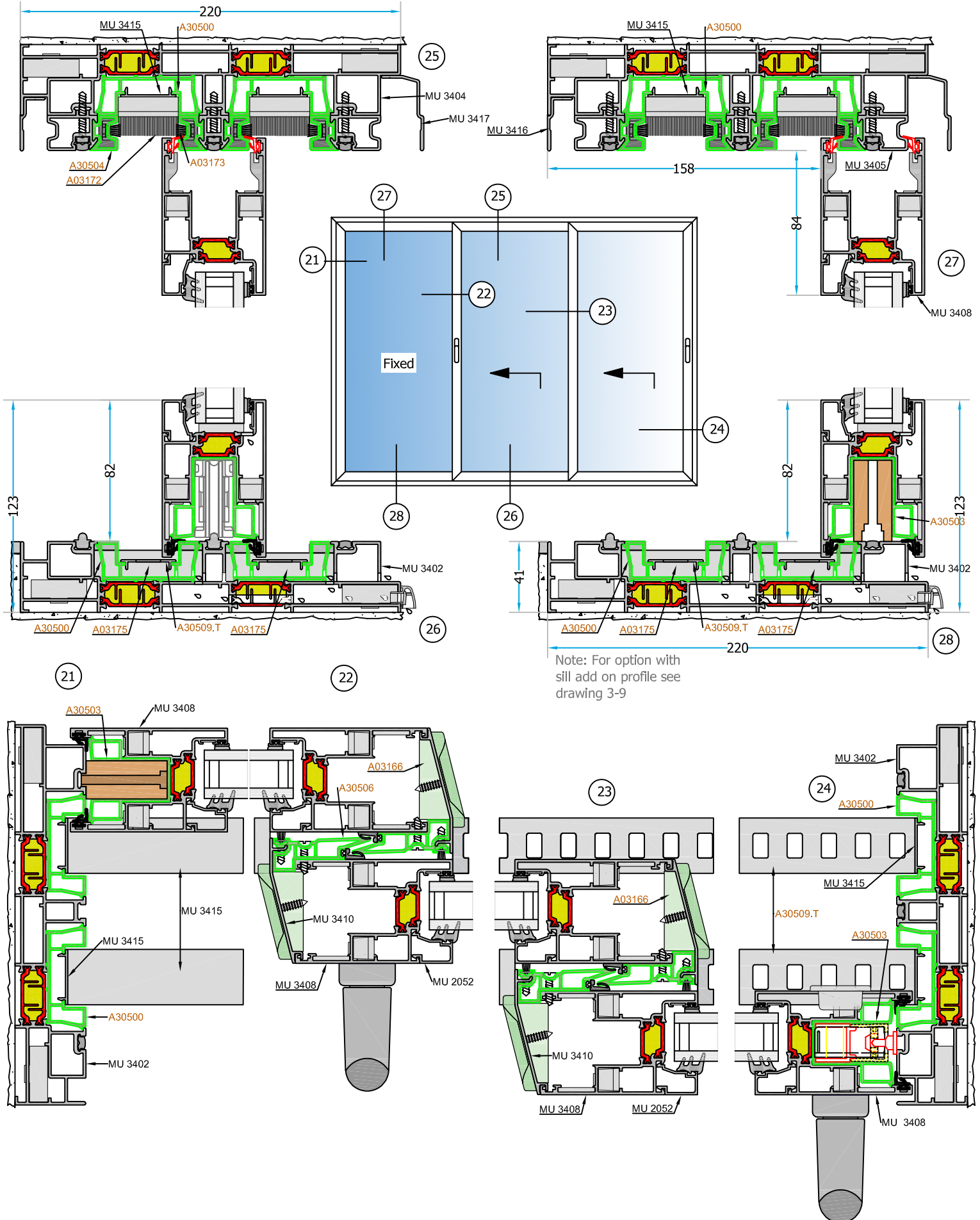
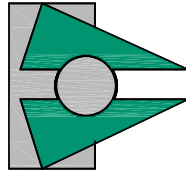

TYPICAL DETAILS

Three pane triple track - 2 sliding & 1 fixed

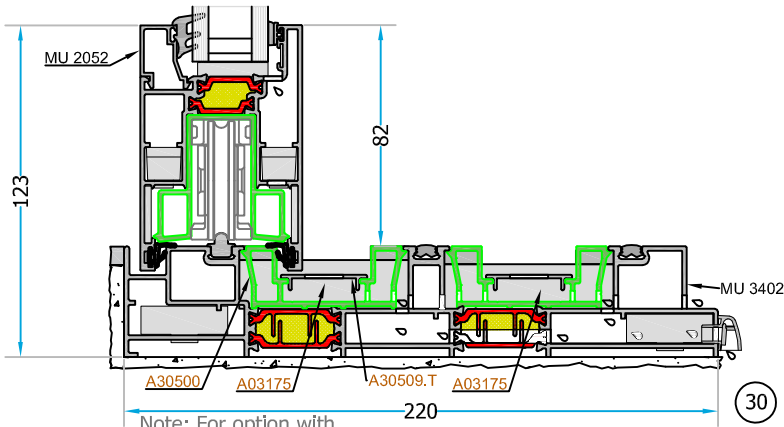
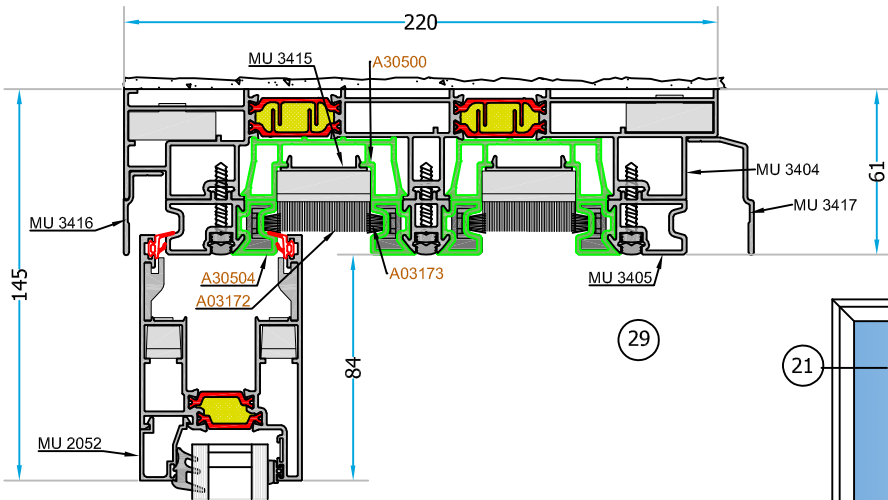
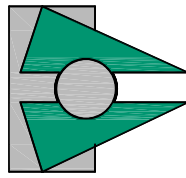

Note: For option with sill add on profile see drawing 3-9

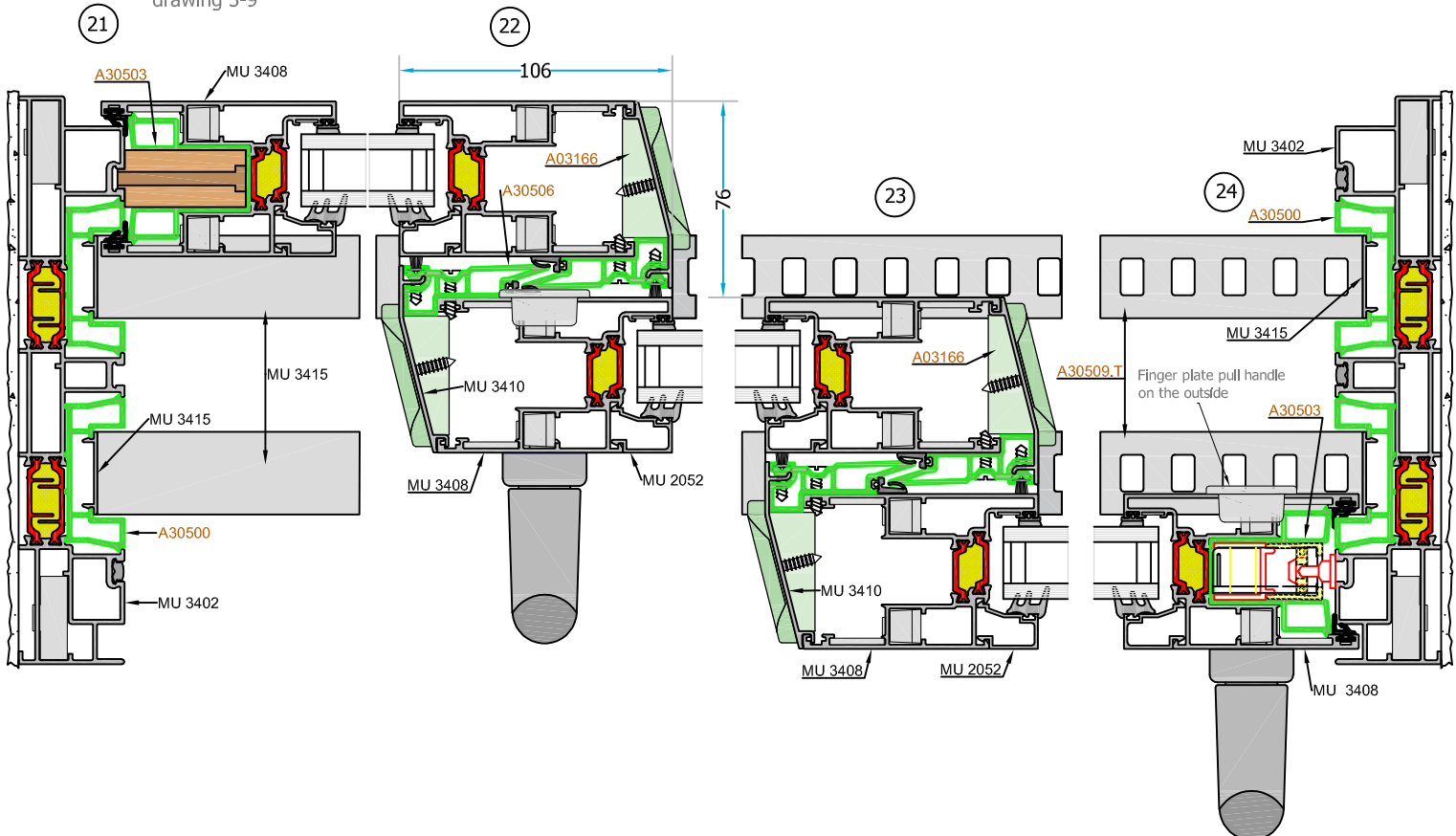
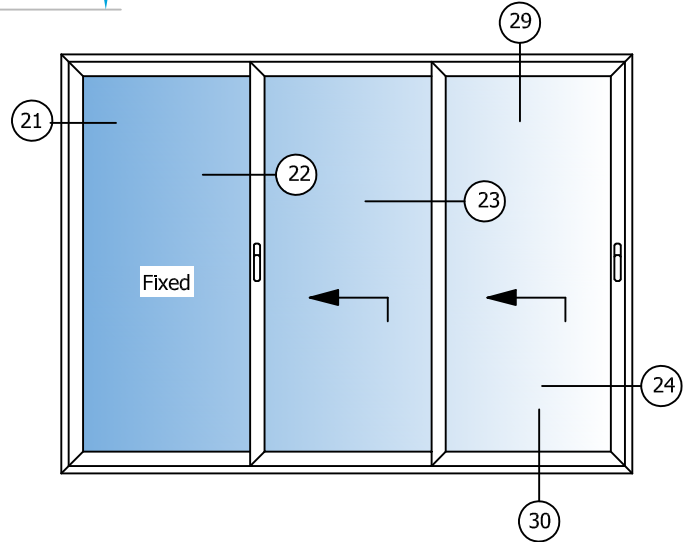

TYPICAL DETAILS

Four pane

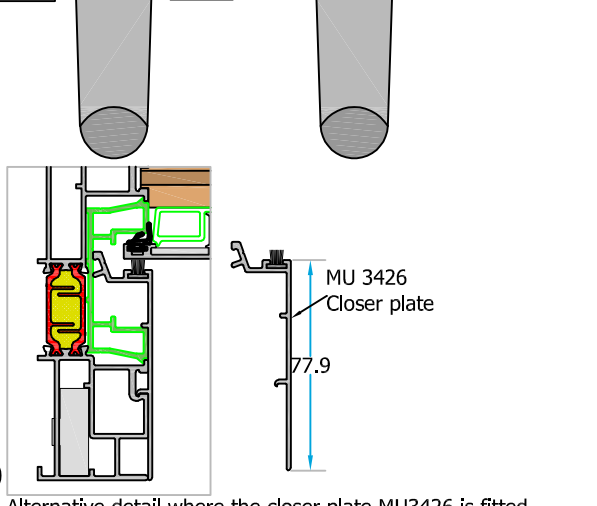
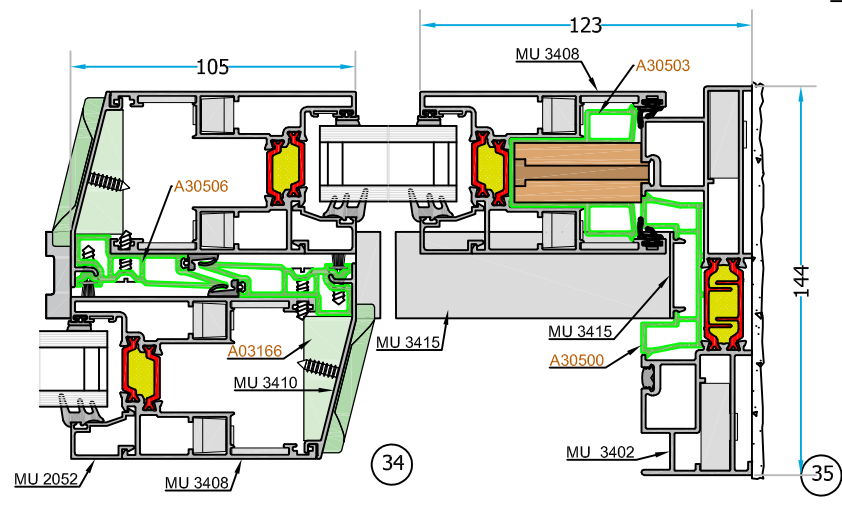
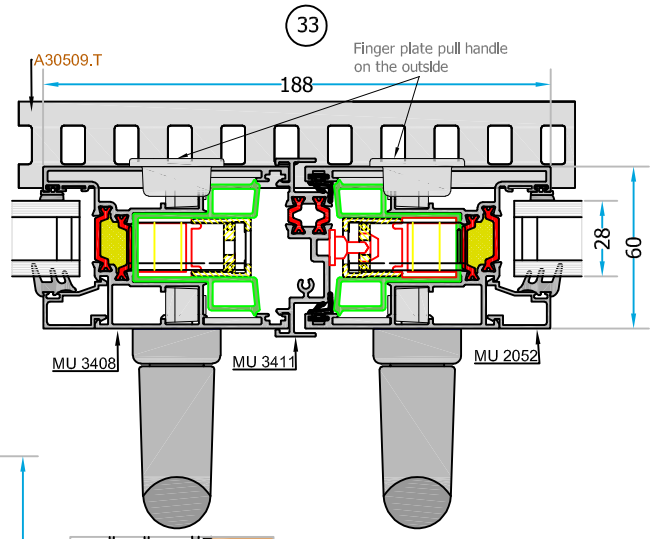
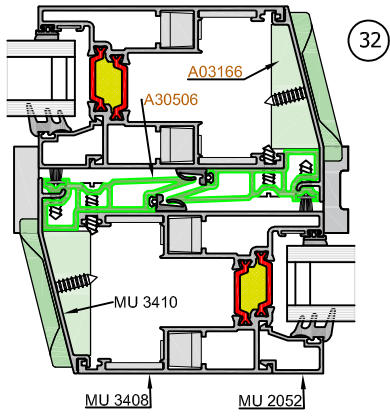
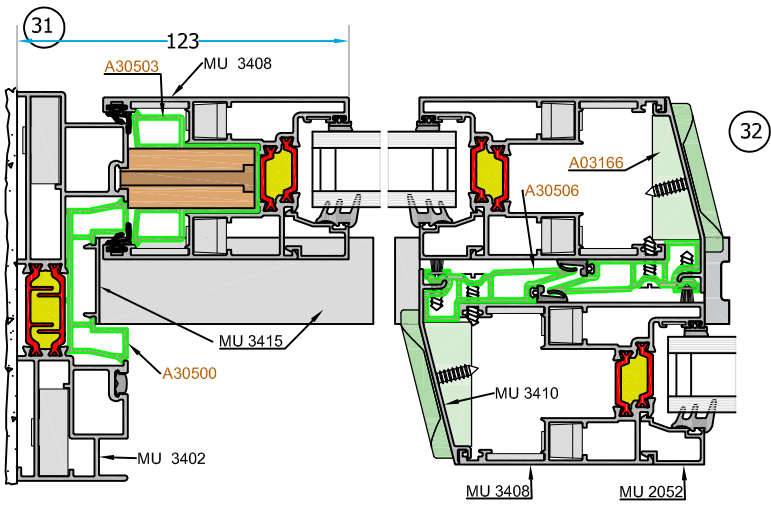
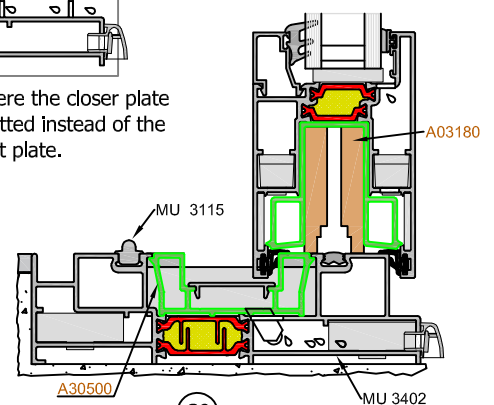
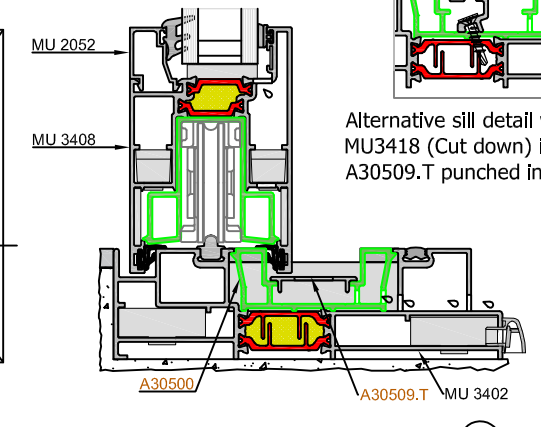
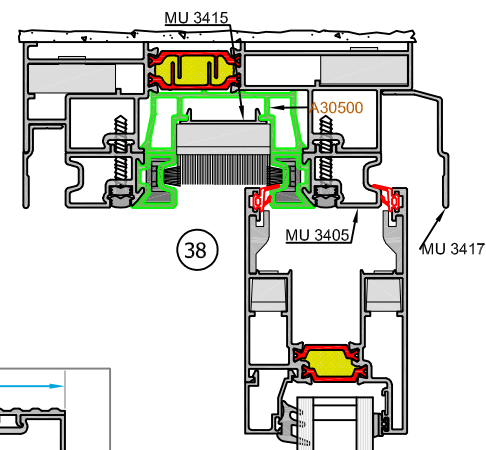
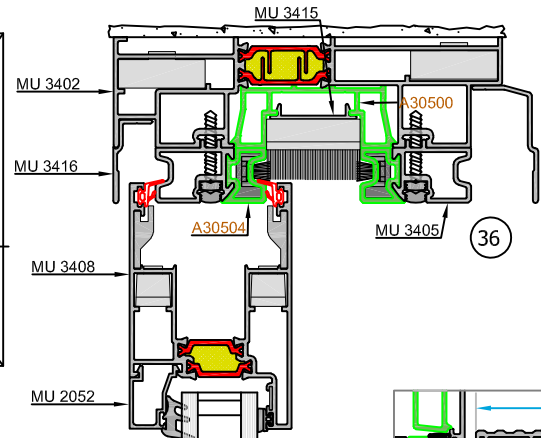
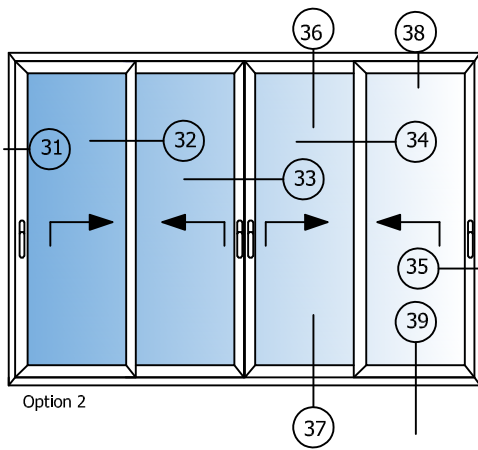
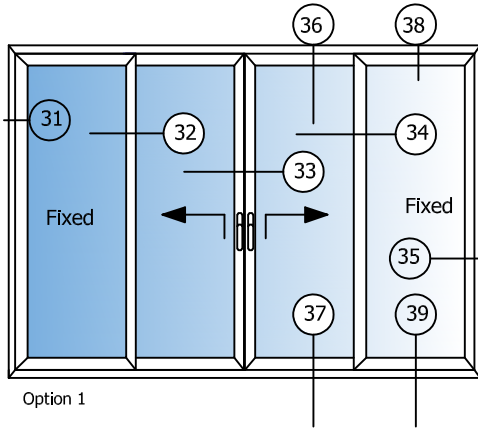
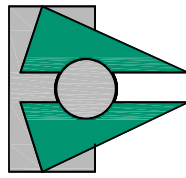

Note: For option with sill add on profile see drawing 3-9

Alternative detail where the closer plate MU3426 is fitted instead of the smaller MU3415 insert plate (on both jambs).

TYPICAL DETAILS

Corner door

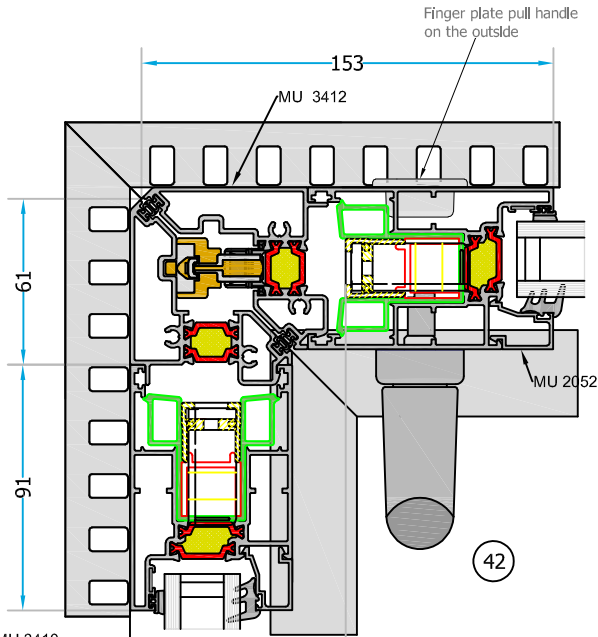
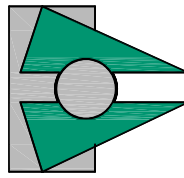

42

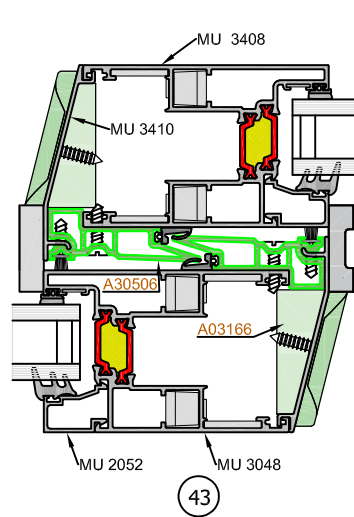

43

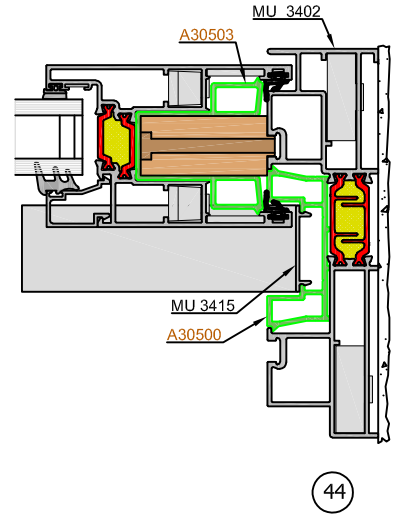

44

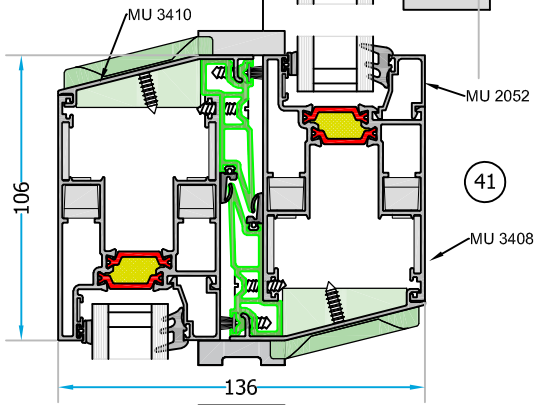

41

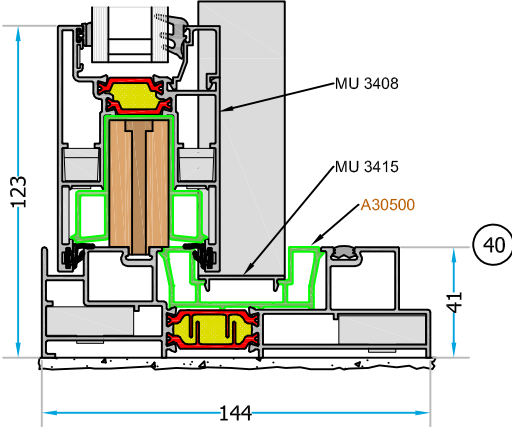
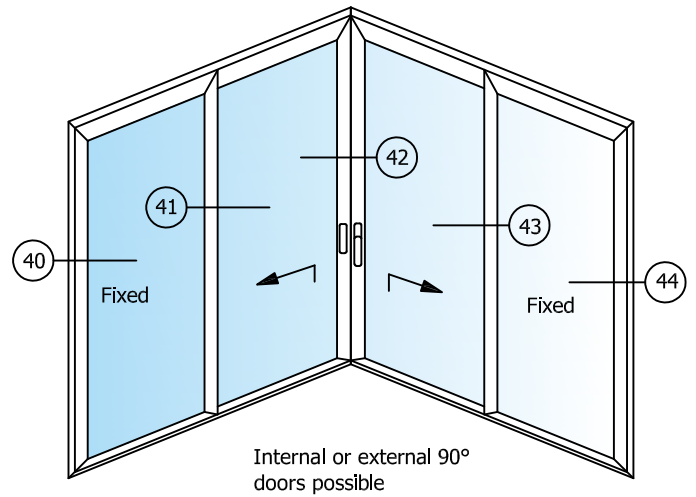

40

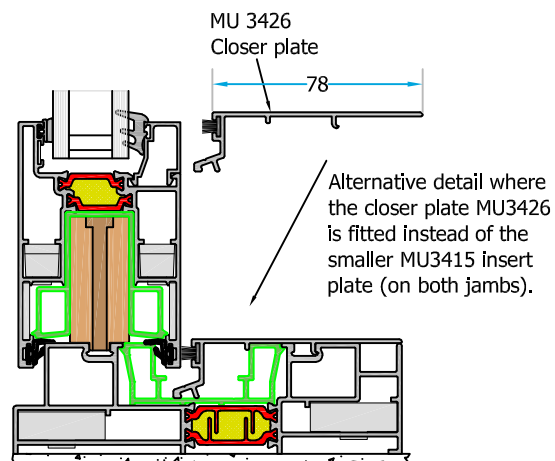

Note: For option with sill add on profile see drawing 3-9



TYPICAL DETAILS

Fixing details

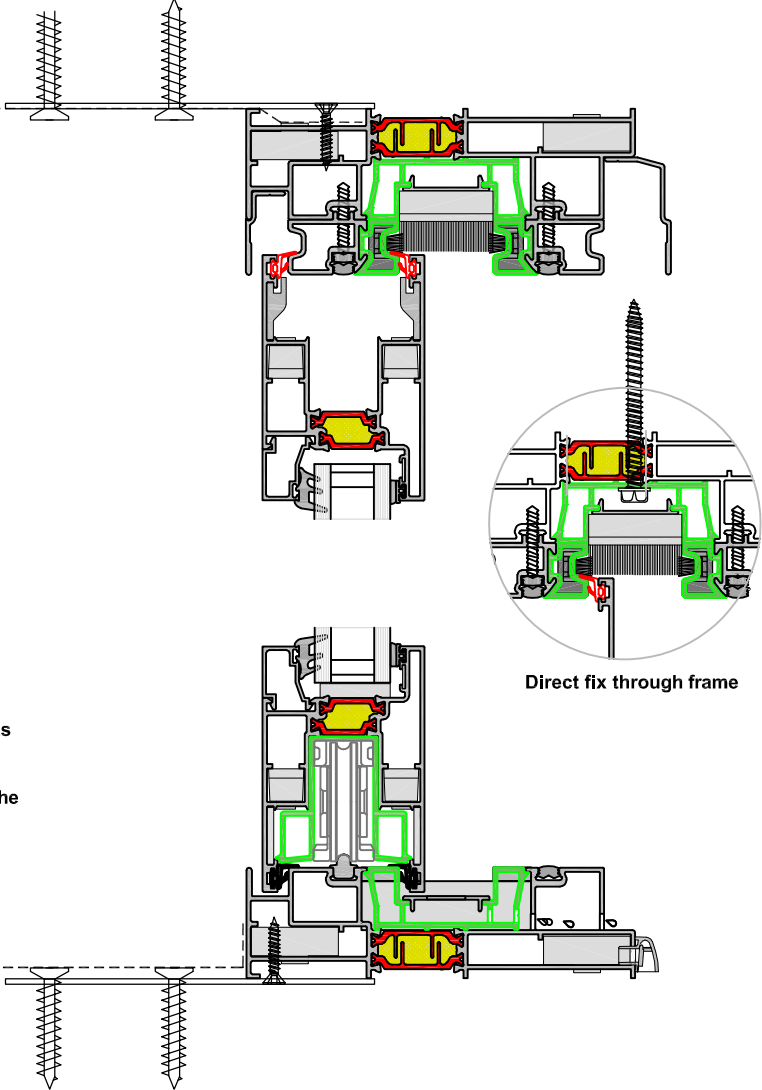
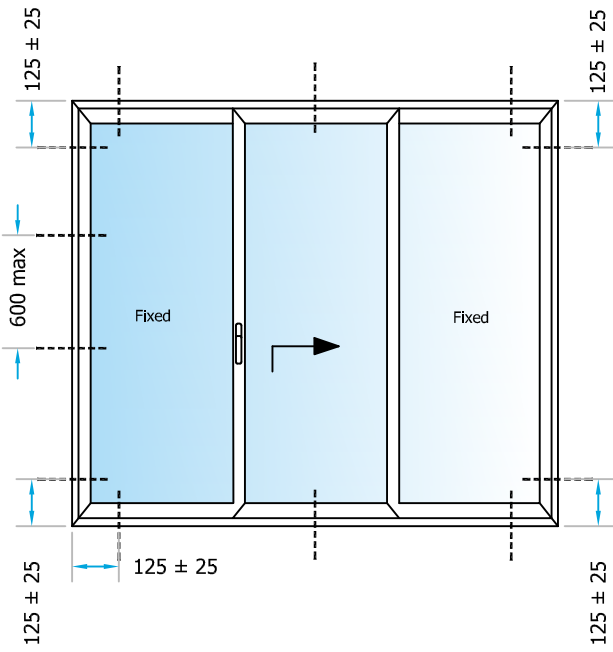
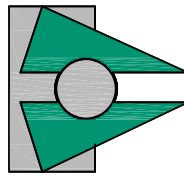

Direct fix through frame

Fixing distances for aluminium windows and doors as per BS 8213-4:2007  
Wherever practicable all four sides of the frame should be secured as follows:

1. Corner jamb fixings should be between 100mm and 150mm from the external corner
2. No fixings should be less than 100mm from the centre line of a mullion or transom
3. Intermediate fixings should be at centres no greater than 600mm
4. There should be a minimum of two fixings on each jamb.
5. On windows over 1800mm wide, central head and sub sill fixings should be provided.

**Note:**  
For the door to function correctly it is essential that the door is level and square and is suitably supported at the sill.

Door frame fixed into position using fixing straps or alternatively direct fix through frame on top and sides. Fixing along the bottom should always be straps as direct fixing the sill could compromise weathering.

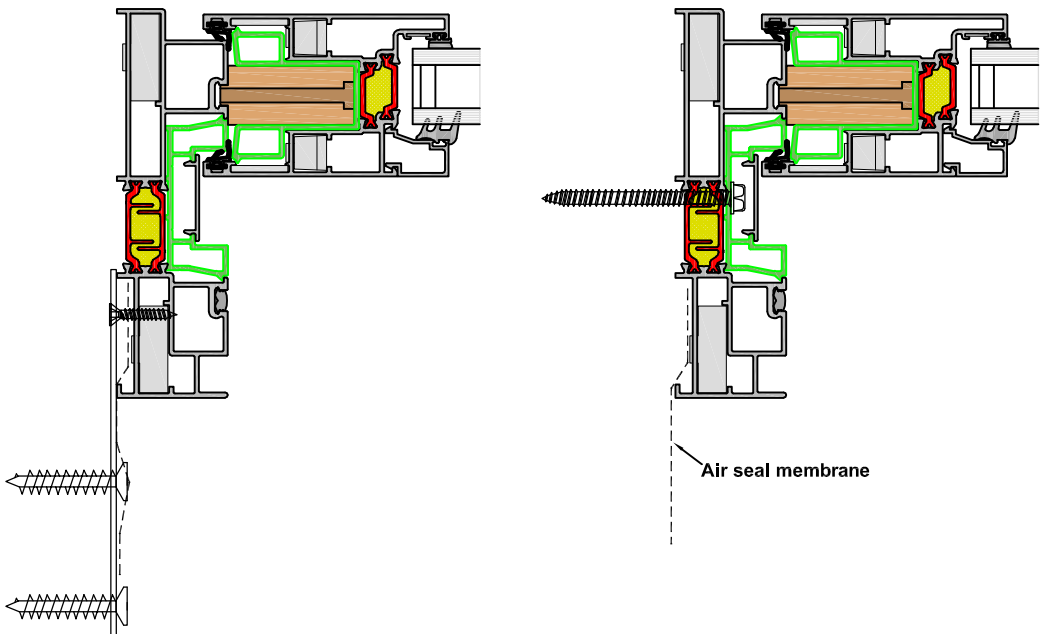

TYPICAL DETAILS

Glazing installation - 3 pane adapter

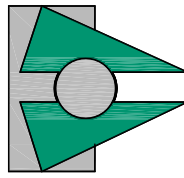

Installing glass next to 3 pane Interlock adapter

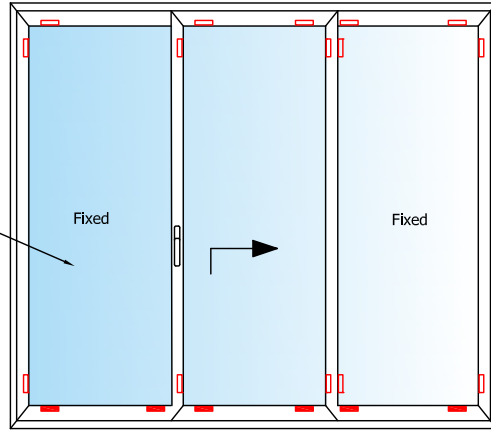

Notes:

1. Ensure glass packers do not cover drainage slots and holes.
2. Packers to be of suitable material and fit for purpose.
3. Refer to BS 8213-4:2007, BS 6262 & BS 8000-7 for recommendations on installation of glass units.
4. In addition to the above, glass unit manufacturer's instructions should be followed.

□ Indicates spacer only

■ Indicates load bearing packer

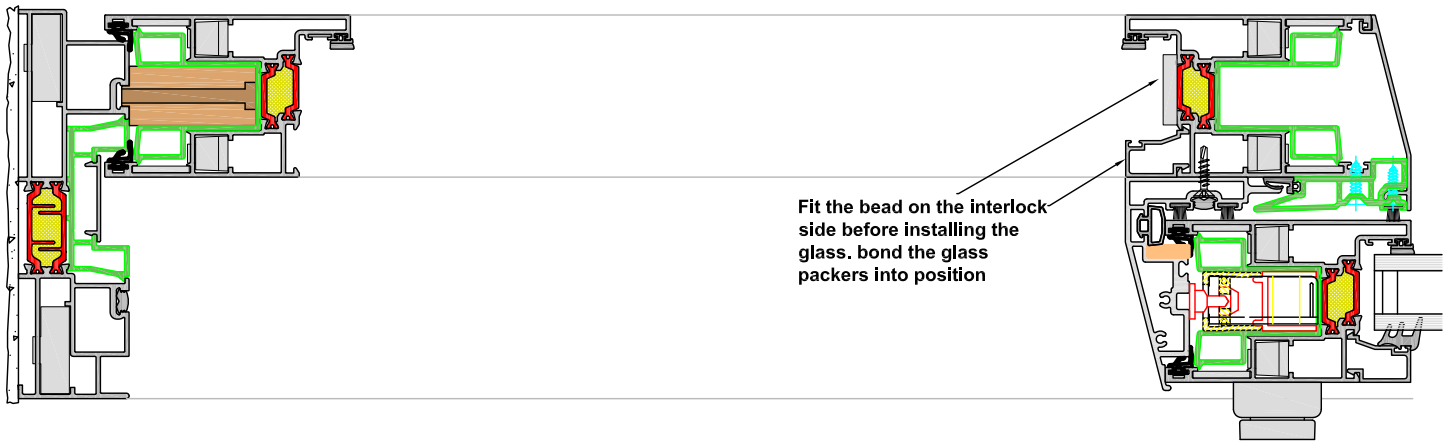

Fit the bead on the interlock side before installing the glass. bond the glass packers into position

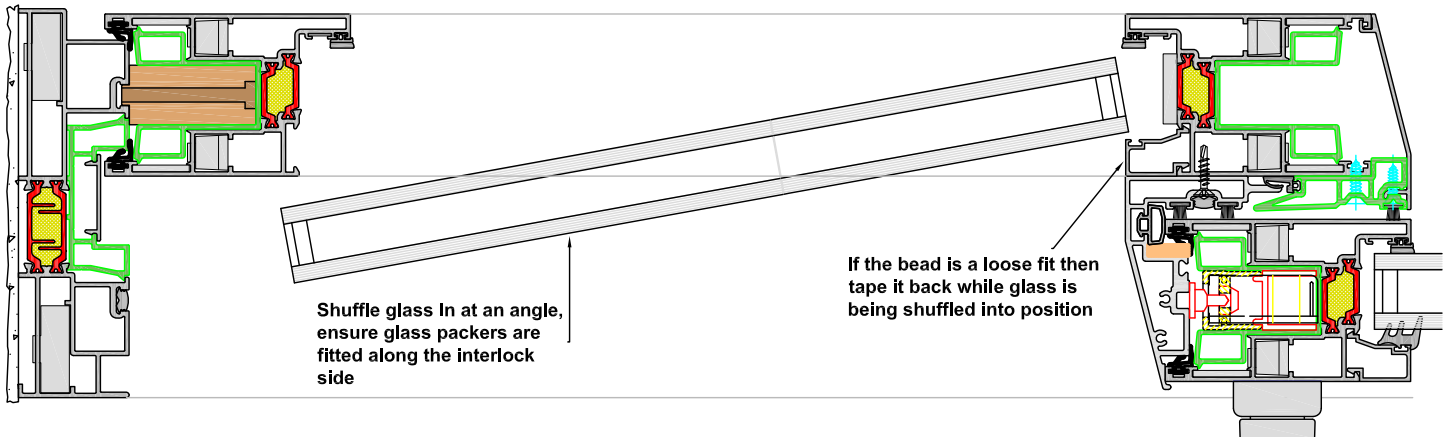

Shuffle glass in at an angle, ensure glass packers are fitted along the interlock side

If the bead is a loose fit then tape it back while glass is being shuffled into position

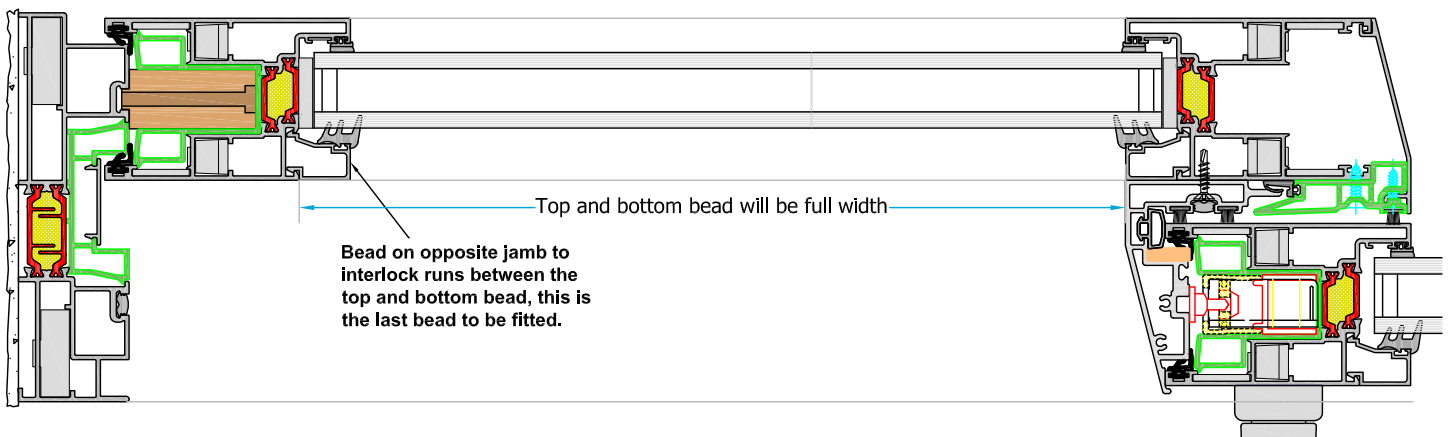

Top and bottom bead will be full width

Bead on opposite jamb to interlock runs between the top and bottom bead, this is the last bead to be fitted.